

DAIKIN



ADDENDUM INSTALLATION MANUAL

VRV Classic **System air conditioner**

RXYCQ24
RXYCQ28
RXYCQ32
RXYCQ38
RXYCQ40

CONTENTS

Page

1. Introduction..... 1
 1.1. Combination..... 1
 1.2. Optional accessories 1
 2. Refrigerant piping 1
 3. Leak test and vacuum drying..... 5
 4. Field wiring 5
 4.1. Power circuit and cable requirements 5
 4.2. System examples5
 4.3. Field line connection: transmission wiring and cool/heat selection 6
 5. Additional refrigerant charge 6
 6. Before operation 7
 6.1. Field setting 7

1. INTRODUCTION

This manual contains additional instructions for the installation of a VRV Classic multiple outdoor unit system. For general instructions regarding the installation of the outdoor units, refer to the VRV classic installation manual.

1.1. Combination

Refer to chapter "1.1.Combination" of the installation manual.

- Total capacity/quantity of indoor units

Standard combination of outdoor units	Total capacity of indoor units
RXYCQ24 = RXYCQ10 + RXYCQ14	300~670
RXYCQ28 = RXYCQ10 + RXYCQ18	350~790
RXYCQ32 = RXYCQ14 + RXYCQ18	400~960
RXYCQ38 = RXYCQ18 + RXYCQ20	475~1140
RXYCQ40 = RXYCQ20 + RXYCQ20	500~1200

NOTE



- There are restrictions on the refrigerant pipe connection order between outdoor units during installation in case of a multiple outdoor unit system. Install according to the following restrictions. The capacities of outdoor units A and B must fulfill the following restriction conditions: **A ≥ B**.
- For RXYCQ Multi only 2 outside units can be connected.

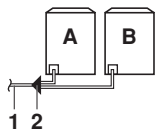

- 1 To indoor units
- 2 Outdoor unit multi connection piping kit (first branch)

1.2. Optional accessories

Refer to chapter "1.3.Optional accessories" of the installation manual.

- Refrigerant branching kit (for R410A only: Always use an appropriate kit dedicated for your system.)

Refnet header	Refnet joint
KHRQ22M29H	KHRQ22M20T
KHRQ22M64H	KHRQ22M29T9
KHRQ22M75H	KHRQ22M64T
	KHRQ22M75T

- Outdoor unit multi connection piping kit (For R410A only: Always use an appropriate kit dedicated for your system.)

Number of outdoor units connected
2
BHFQ22P1007

- Pipe size reducer (For R410A only: Always use an appropriate kit dedicated for your system.)

RXYCQ22~40	
KHRQ22M75T	KHRQ22M75H

2. REFRIGERANT PIPING

Refer to chapter "6.Refrigerant piping" of the installation manual.

1 Outdoor units installed in a multiple outdoor unit system: RXYCQ24~40

- Front connection: Remove the stop valve cover to connect (A).
- Bottom connection: Remove the knock holes on the bottom frame and route the piping under the bottom frame (B).

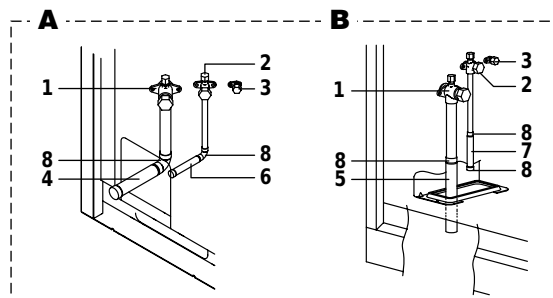

1.1 Precautions when connecting piping between outdoor units (multiple outdoor unit system)

- The 8 Hp unit type can not be used as an independent unit in a multi system.
- To connect the piping between outdoor units, an optional multi connection piping kit BHFQ22P1007 is always required. When installing the piping, follow the instructions in the installation manual that comes with the kit.
- Only proceed with piping work after considering the limitations on installing listed in the RXYCQ installation manual, always referring to the installation manual delivered with the kit.

1.2 Possible installation patterns and configurations

- The piping between the outdoor units must be routed level or slightly upward to avoid the risk of oil retention into the piping side.

Pattern 1



1 To indoor unit

Pattern 2



1 To indoor unit

Prohibited patterns: change to pattern 1 or 2.

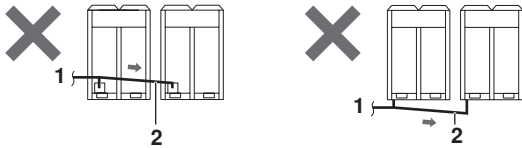

1 To indoor unit
2 Piping between outdoor units

- To avoid the risk of oil retention to the outmost outdoor unit, always connect the stop valve and the piping between outdoor units as shown in the 4 correct possibilities of the figure below.

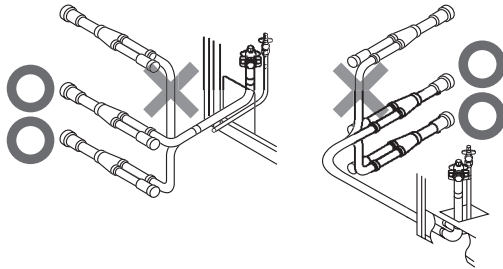

Prohibited patterns: change to pattern 1 or 2.

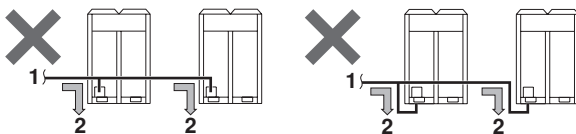

1 To indoor unit
2 Oil collects to the outmost outdoor unit.

Change to configuration as in figures below

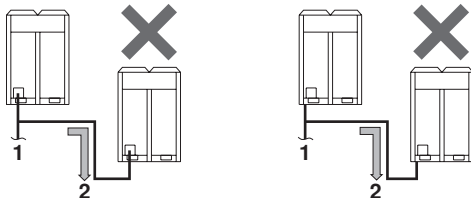

1 To indoor unit
2 Oil collects to the outmost outdoor unit when the system stops.

Correct configuration

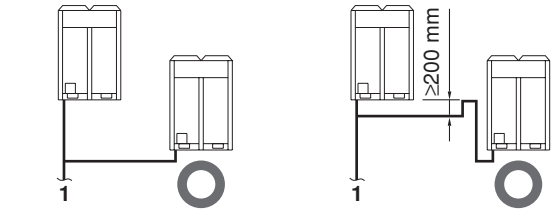

1 To indoor unit

- If the piping length between the outdoor units exceeds 2 m, create a rise of 200 mm or more in the gas line within a length of 2 m from the kit.

- If ≤ 2 m

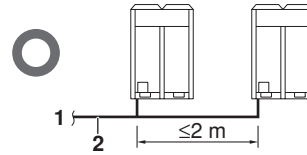



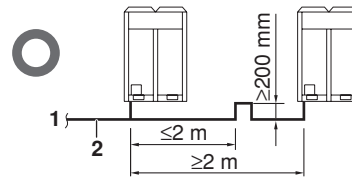

1 To indoor unit
2 Piping between outdoor units

- If ≥ 2 m



1 To indoor unit
2 Piping between outdoor units

2.1. Example of connection

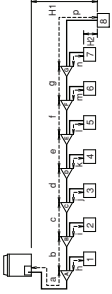
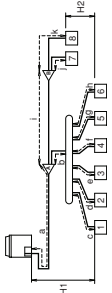
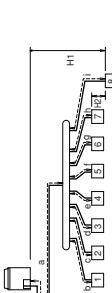
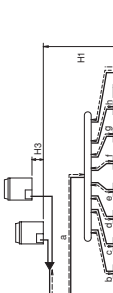
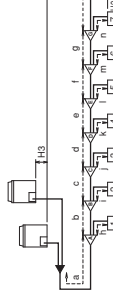
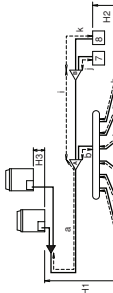
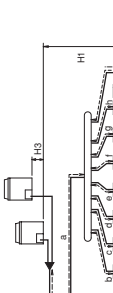
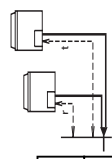
Example of connection (Connection of 8 indoor units Heat pump system)		Branch with refnet joint	Branch with refnet joint and refnet header	Branch with refnet header																																																														
<p>A</p> <ul style="list-style-type: none"> Use the outdoor unit multi connection piping kit that is sold separately as an option (BHFQ22P1007) for the multi installation of outdoor units. Selection method is as shown in the right table. Do not use the outdoor unit multi connection piping kit (BHFQ22M09+1359) that are sold separately as an option of the M-type series and do not use T-joints. <p>  indoor unit  refnet joint  refnet header  outdoor multi connection piping kit </p> <p>Install the joint part (◀ part in the figure) of the outdoor unit multi connection piping kit horizontally with attention to the installation restrictions described in "connecting the refrigerant piping". (*) If the system capacity is 24 or more, re-read to the first outdoor branch as seen from the indoor unit.</p>	<p>One outdoor unit installed (RXYYCQ8-20)</p> 	<p>Branch with refnet joint</p> 	<p>Branch with refnet joint and refnet header</p> 	<p>Branch with refnet header</p> 																																																														
	<p>Outdoor units installed in a multiple outdoor unit system (RXYYCQ24-40)</p> 	<p>Branch with refnet joint and refnet header</p> 	<p>Branch with refnet header</p> 																																																															
<p>Maximum allowable length</p> <p>Between outdoor and indoor units</p> <p>Between outdoor branch and outdoor unit (Only for RXYYCQ24 or more)</p> <p>Between outdoor and indoor units</p> <p>Between indoor and indoor units</p> <p>Between outdoor and outdoor units</p>	<p>Actual pipe length</p> <p>Equivalent length</p> <p>Total extension length</p> <p>Actual pipe length</p> <p>Difference in height</p> <p>Difference in height</p> <p>Difference in height</p> <p>Actual pipe length</p>	<p>Pipe length between outdoor(*) and indoor units ≤135 m</p> <p>[Example] unit 8: a+b+c+d+e+f+g+p≤135 m</p> <p>[Example] unit 6: a+b+h≤135 m, unit 8: a+i+k≤135 m</p> <p>[Example] unit 8: a+i≤135 m</p>	<p>Equivalant pipe length between outdoor(*) and indoor units ≤155 m (Assume equivalent pipe length of refnet joint to be 0.5 m and of the refnet header to be 1.0 m. (for calculation purposes))</p> <p>Total piping length from outdoor unit* to all indoor units ≤300 m</p> <p>Piping length from outdoor branch to outdoor unit ≤10 m. Approximate length: max. 13 m</p> <p>Difference in height between outdoor and indoor units (H1) ≤30 m.</p> <p>Difference in height between adjacent indoor units (H2) ≤15 m</p> <p>Difference in height between outdoor unit (main) and outdoor unit (sub) (H3) ≤5 m</p> <p>Pipe length from first refrigerant branch kit (either refnet joint or refnet header) to indoor unit ≤40 m (See note 1 on next page)</p> <p>[Example] unit 8: i+k≤40 m</p> <p>[Example] unit 8: i≤40 m</p>	<p>rs=10 m (Approximate length: max. 13 m)</p> <p>ts=10 m (Approximate length: max. 13 m)</p> 																																																														
	<p>Allowable height</p>	<p>Actual pipe length</p>	<p>Actual pipe length</p>	<p>Actual pipe length</p>	<p>Actual pipe length</p>																																																													
<p>Allowable length after the branch</p> <p>Refrigerant branch kit selection</p> <p>Refrigerant branch kits can only be used with R410A.</p>	<p>How to select the refnet joint</p> <ul style="list-style-type: none"> When using refnet joints at the first branch counted from the outdoor unit side. Choose from the following table in accordance with the capacity of the outdoor unit. <table border="1"> <thead> <tr> <th>Outdoor unit capacity type</th> <th>Refrigerant branch kit name</th> </tr> </thead> <tbody> <tr> <td>RXYCQ8</td> <td>KHRQ22M20T</td> </tr> <tr> <td>RXYCQ10-12</td> <td>KHRQ22M29T9</td> </tr> <tr> <td>RXYCQ14-20, 24</td> <td>KHRQ22M64T</td> </tr> <tr> <td>RXYCQ28, 32, 38, 40</td> <td>KHRQ22M75T</td> </tr> </tbody> </table> <p>• For refnet joints other than the first branch, select the proper branch kit model based on the total capacity index.</p> <table border="1"> <thead> <tr> <th>Indoor capacity type</th> <th>Refrigerant branch kit name</th> </tr> </thead> <tbody> <tr> <td><200</td> <td>KHRQ22M20T</td> </tr> <tr> <td>200≤x<290</td> <td>KHRQ22M29T9</td> </tr> <tr> <td>290≤x<640</td> <td>KHRQ22M64T</td> </tr> <tr> <td>≥640</td> <td>KHRQ22M75T</td> </tr> </tbody> </table> <p>How to select the refnet header</p> <ul style="list-style-type: none"> Choose from the following table in accordance with the total capacity of all the indoor units connected below the refnet header. Note: 250 type cannot be connected below the refnet header. <table border="1"> <thead> <tr> <th>Indoor capacity type</th> <th>Refrigerant branch kit name</th> </tr> </thead> <tbody> <tr> <td><290</td> <td>KHRQ22M29H (Max. 8 branch)</td> </tr> <tr> <td>290≤x<640</td> <td>KHRQ22M64H (Max. 8 branch)(a)</td> </tr> <tr> <td>≥640</td> <td>KHRQ22M75H (Max. 8 branch)</td> </tr> </tbody> </table> <p>(a) See note 2 on next page</p> <p>How to choose an outdoor multi connection piping kit (needed if the outdoor unit capacity type is RXYCQ24 or more.)</p> <ul style="list-style-type: none"> Choose from the following table in accordance with the number of outdoor units. <table border="1"> <thead> <tr> <th>Number of outdoor units</th> <th>Branch kit name</th> </tr> </thead> <tbody> <tr> <td>2</td> <td>BHFQ22P1007</td> </tr> </tbody> </table>	Outdoor unit capacity type	Refrigerant branch kit name	RXYCQ8	KHRQ22M20T	RXYCQ10-12	KHRQ22M29T9	RXYCQ14-20, 24	KHRQ22M64T	RXYCQ28, 32, 38, 40	KHRQ22M75T	Indoor capacity type	Refrigerant branch kit name	<200	KHRQ22M20T	200≤x<290	KHRQ22M29T9	290≤x<640	KHRQ22M64T	≥640	KHRQ22M75T	Indoor capacity type	Refrigerant branch kit name	<290	KHRQ22M29H (Max. 8 branch)	290≤x<640	KHRQ22M64H (Max. 8 branch)(a)	≥640	KHRQ22M75H (Max. 8 branch)	Number of outdoor units	Branch kit name	2	BHFQ22P1007	<p>How to select the refnet joint</p> <ul style="list-style-type: none"> When using refnet joints at the first branch counted from the outdoor unit side. Choose from the following table in accordance with the capacity of the outdoor unit. <table border="1"> <thead> <tr> <th>Outdoor unit capacity type</th> <th>Refrigerant branch kit name</th> </tr> </thead> <tbody> <tr> <td>RXYCQ8</td> <td>KHRQ22M20T</td> </tr> <tr> <td>RXYCQ10-12</td> <td>KHRQ22M29T9</td> </tr> <tr> <td>RXYCQ14-20, 24</td> <td>KHRQ22M64T</td> </tr> <tr> <td>RXYCQ28, 32, 38, 40</td> <td>KHRQ22M75T</td> </tr> </tbody> </table> <p>• For refnet joints other than the first branch, select the proper branch kit model based on the total capacity index.</p> <table border="1"> <thead> <tr> <th>Indoor capacity type</th> <th>Refrigerant branch kit name</th> </tr> </thead> <tbody> <tr> <td><200</td> <td>KHRQ22M20T</td> </tr> <tr> <td>200≤x<290</td> <td>KHRQ22M29T9</td> </tr> <tr> <td>290≤x<640</td> <td>KHRQ22M64T</td> </tr> <tr> <td>≥640</td> <td>KHRQ22M75T</td> </tr> </tbody> </table> <p>How to select the refnet header</p> <ul style="list-style-type: none"> Choose from the following table in accordance with the total capacity of all the indoor units connected below the refnet header. Note: 250 type cannot be connected below the refnet header. <table border="1"> <thead> <tr> <th>Indoor capacity type</th> <th>Refrigerant branch kit name</th> </tr> </thead> <tbody> <tr> <td><290</td> <td>KHRQ22M29H (Max. 8 branch)</td> </tr> <tr> <td>290≤x<640</td> <td>KHRQ22M64H (Max. 8 branch)(a)</td> </tr> <tr> <td>≥640</td> <td>KHRQ22M75H (Max. 8 branch)</td> </tr> </tbody> </table> <p>(a) See note 2 on next page</p> <p>How to choose an outdoor multi connection piping kit (needed if the outdoor unit capacity type is RXYCQ24 or more.)</p> <ul style="list-style-type: none"> Choose from the following table in accordance with the number of outdoor units. <table border="1"> <thead> <tr> <th>Number of outdoor units</th> <th>Branch kit name</th> </tr> </thead> <tbody> <tr> <td>2</td> <td>BHFQ22P1007</td> </tr> </tbody> </table>	Outdoor unit capacity type	Refrigerant branch kit name	RXYCQ8	KHRQ22M20T	RXYCQ10-12	KHRQ22M29T9	RXYCQ14-20, 24	KHRQ22M64T	RXYCQ28, 32, 38, 40	KHRQ22M75T	Indoor capacity type	Refrigerant branch kit name	<200	KHRQ22M20T	200≤x<290	KHRQ22M29T9	290≤x<640	KHRQ22M64T	≥640	KHRQ22M75T	Indoor capacity type	Refrigerant branch kit name	<290	KHRQ22M29H (Max. 8 branch)	290≤x<640	KHRQ22M64H (Max. 8 branch)(a)	≥640	KHRQ22M75H (Max. 8 branch)	Number of outdoor units	Branch kit name	2	BHFQ22P1007
Outdoor unit capacity type	Refrigerant branch kit name																																																																	
RXYCQ8	KHRQ22M20T																																																																	
RXYCQ10-12	KHRQ22M29T9																																																																	
RXYCQ14-20, 24	KHRQ22M64T																																																																	
RXYCQ28, 32, 38, 40	KHRQ22M75T																																																																	
Indoor capacity type	Refrigerant branch kit name																																																																	
<200	KHRQ22M20T																																																																	
200≤x<290	KHRQ22M29T9																																																																	
290≤x<640	KHRQ22M64T																																																																	
≥640	KHRQ22M75T																																																																	
Indoor capacity type	Refrigerant branch kit name																																																																	
<290	KHRQ22M29H (Max. 8 branch)																																																																	
290≤x<640	KHRQ22M64H (Max. 8 branch)(a)																																																																	
≥640	KHRQ22M75H (Max. 8 branch)																																																																	
Number of outdoor units	Branch kit name																																																																	
2	BHFQ22P1007																																																																	
Outdoor unit capacity type	Refrigerant branch kit name																																																																	
RXYCQ8	KHRQ22M20T																																																																	
RXYCQ10-12	KHRQ22M29T9																																																																	
RXYCQ14-20, 24	KHRQ22M64T																																																																	
RXYCQ28, 32, 38, 40	KHRQ22M75T																																																																	
Indoor capacity type	Refrigerant branch kit name																																																																	
<200	KHRQ22M20T																																																																	
200≤x<290	KHRQ22M29T9																																																																	
290≤x<640	KHRQ22M64T																																																																	
≥640	KHRQ22M75T																																																																	
Indoor capacity type	Refrigerant branch kit name																																																																	
<290	KHRQ22M29H (Max. 8 branch)																																																																	
290≤x<640	KHRQ22M64H (Max. 8 branch)(a)																																																																	
≥640	KHRQ22M75H (Max. 8 branch)																																																																	
Number of outdoor units	Branch kit name																																																																	
2	BHFQ22P1007																																																																	
<p>Example of downstream indoor units</p>	<p>[Example] in case of refnet joint C; indoor units 3+4+5+6+7+8</p>	<p>[Example] in case of refnet joint B; indoor units 7+8, in case of refnet header; indoor units 1+2+3+4+5+6</p>	<p>[Example] in case of refnet header; indoor units 1+2+3+4+5+6+7+8</p>																																																															

Pipe size selection For an outdoor unit multi installation (RXYCQ24~40A), select the pipe size in accordance with the following figure.		A.B. Piping between outdoor unit and refrigerant branch kit • Choose from the following table in accordance with the outdoor unit total capacity type, connected downstream. Outdoor unit connection piping size	D. Piping between refrigerant branch kits • Choose from the following table in accordance with the total capacity of all the indoor units connected below this. • Do not let the connection piping exceed the refrigerant piping size chosen by general system model name.	E. Piping between refrigerant branch kit and indoor unit • Pipe size for direct connection to indoor unit must be the same as the connection size of indoor unit.																																																																						
		<table border="1"> <thead> <tr> <th>Outdoor unit capacity type</th> <th colspan="2">Piping size (outer diameter) (mm)</th> </tr> <tr> <th></th> <th>Gas pipe</th> <th>Liquid pipe</th> </tr> </thead> <tbody> <tr> <td>RXYCQ8</td> <td>Ø15.9</td> <td>Ø9.5</td> </tr> <tr> <td>RXYCQ10</td> <td>Ø19.1</td> <td>Ø9.5</td> </tr> <tr> <td>RXYCQ12</td> <td>Ø22.2</td> <td>Ø12.7</td> </tr> <tr> <td>RXYCQ14~18</td> <td>Ø28.6</td> <td>Ø15.9</td> </tr> <tr> <td>RXYCQ20, 24</td> <td>Ø34.9</td> <td>Ø19.1</td> </tr> <tr> <td>RXYCQ28</td> <td>Ø41.3</td> <td>—</td> </tr> <tr> <td>RXYCQ32, 38</td> <td>—</td> <td>—</td> </tr> <tr> <td>RXYCQ40</td> <td>—</td> <td>—</td> </tr> </tbody> </table>	Outdoor unit capacity type	Piping size (outer diameter) (mm)			Gas pipe	Liquid pipe	RXYCQ8	Ø15.9	Ø9.5	RXYCQ10	Ø19.1	Ø9.5	RXYCQ12	Ø22.2	Ø12.7	RXYCQ14~18	Ø28.6	Ø15.9	RXYCQ20, 24	Ø34.9	Ø19.1	RXYCQ28	Ø41.3	—	RXYCQ32, 38	—	—	RXYCQ40	—	—	<table border="1"> <thead> <tr> <th>Indoor or outdoor unit total capacity</th> <th colspan="2">Piping size (outer diameter) (mm)</th> </tr> <tr> <th></th> <th>Gas pipe</th> <th>Liquid pipe</th> </tr> </thead> <tbody> <tr> <td><150</td> <td>Ø15.9</td> <td>Ø9.5</td> </tr> <tr> <td>150~x<200</td> <td>Ø19.1</td> <td>Ø9.5</td> </tr> <tr> <td>200~x<290</td> <td>Ø22.2</td> <td>Ø12.7</td> </tr> <tr> <td>290~x<420</td> <td>Ø28.6</td> <td>Ø15.9</td> </tr> <tr> <td>420~x<640</td> <td>Ø34.9</td> <td>Ø19.1</td> </tr> <tr> <td>≥640</td> <td>Ø41.3</td> <td>—</td> </tr> </tbody> </table>	Indoor or outdoor unit total capacity	Piping size (outer diameter) (mm)			Gas pipe	Liquid pipe	<150	Ø15.9	Ø9.5	150~x<200	Ø19.1	Ø9.5	200~x<290	Ø22.2	Ø12.7	290~x<420	Ø28.6	Ø15.9	420~x<640	Ø34.9	Ø19.1	≥640	Ø41.3	—	<table border="1"> <thead> <tr> <th>Indoor capacity type</th> <th colspan="2">Piping size (outer diameter) (mm)</th> </tr> <tr> <th></th> <th>Gas pipe</th> <th>Liquid pipe</th> </tr> </thead> <tbody> <tr> <td>20~50</td> <td>Ø12.7</td> <td>Ø6.4</td> </tr> <tr> <td>63~125</td> <td>Ø15.9</td> <td>Ø9.5</td> </tr> <tr> <td>200</td> <td>Ø19.1</td> <td>—</td> </tr> <tr> <td>250</td> <td>Ø22.2</td> <td>—</td> </tr> </tbody> </table>	Indoor capacity type	Piping size (outer diameter) (mm)			Gas pipe	Liquid pipe	20~50	Ø12.7	Ø6.4	63~125	Ø15.9	Ø9.5	200	Ø19.1	—	250
Outdoor unit capacity type	Piping size (outer diameter) (mm)																																																																									
	Gas pipe	Liquid pipe																																																																								
RXYCQ8	Ø15.9	Ø9.5																																																																								
RXYCQ10	Ø19.1	Ø9.5																																																																								
RXYCQ12	Ø22.2	Ø12.7																																																																								
RXYCQ14~18	Ø28.6	Ø15.9																																																																								
RXYCQ20, 24	Ø34.9	Ø19.1																																																																								
RXYCQ28	Ø41.3	—																																																																								
RXYCQ32, 38	—	—																																																																								
RXYCQ40	—	—																																																																								
Indoor or outdoor unit total capacity	Piping size (outer diameter) (mm)																																																																									
	Gas pipe	Liquid pipe																																																																								
<150	Ø15.9	Ø9.5																																																																								
150~x<200	Ø19.1	Ø9.5																																																																								
200~x<290	Ø22.2	Ø12.7																																																																								
290~x<420	Ø28.6	Ø15.9																																																																								
420~x<640	Ø34.9	Ø19.1																																																																								
≥640	Ø41.3	—																																																																								
Indoor capacity type	Piping size (outer diameter) (mm)																																																																									
	Gas pipe	Liquid pipe																																																																								
20~50	Ø12.7	Ø6.4																																																																								
63~125	Ø15.9	Ø9.5																																																																								
200	Ø19.1	—																																																																								
250	Ø22.2	—																																																																								

When the equivalent pipe length between outdoor and indoor units is 90 m or more, the size of the main pipes (both gas side and liquid side) must be increased. Depending on the length of the piping, the capacity may drop, but even in such a case it is possible to increase the size of the main pipes.	<table border="1"> <thead> <tr> <th></th> <th>Gas side</th> <th>Liquid side</th> </tr> </thead> <tbody> <tr> <td>RXYCQ8</td> <td>Ø15.9 → Ø19.1</td> <td>Ø9.5</td> </tr> <tr> <td>RXYCQ10</td> <td>Ø19.1 → Ø22.2</td> <td>Ø9.5 → Ø12.7</td> </tr> <tr> <td>RXYCQ12</td> <td>Ø22.2 → Ø25.4^(a)</td> <td>Ø12.7 → Ø15.9</td> </tr> <tr> <td>RXYCQ14~16</td> <td>Ø28.6</td> <td>Ø15.9 → Ø19.1</td> </tr> <tr> <td>RXYCQ18, 20, 24</td> <td>Ø28.6 → Ø31.8^(a)</td> <td>Ø19.1 → Ø22.2</td> </tr> <tr> <td>RXYCQ28</td> <td>Ø34.9</td> <td>—</td> </tr> <tr> <td>RXYCQ32, 38</td> <td>Ø34.9 → Ø38.1^(a)</td> <td>—</td> </tr> <tr> <td>RXYCQ40</td> <td>Ø41.3</td> <td>—</td> </tr> </tbody> </table> <p>— Increase is not allowed (a) If not available, increase is not allowed</p>		Gas side	Liquid side	RXYCQ8	Ø15.9 → Ø19.1	Ø9.5	RXYCQ10	Ø19.1 → Ø22.2	Ø9.5 → Ø12.7	RXYCQ12	Ø22.2 → Ø25.4 ^(a)	Ø12.7 → Ø15.9	RXYCQ14~16	Ø28.6	Ø15.9 → Ø19.1	RXYCQ18, 20, 24	Ø28.6 → Ø31.8 ^(a)	Ø19.1 → Ø22.2	RXYCQ28	Ø34.9	—	RXYCQ32, 38	Ø34.9 → Ø38.1 ^(a)	—	RXYCQ40	Ø41.3	—	<ol style="list-style-type: none"> Outdoor unit Main pipes Increase First refrigerant branch kit Indoor unit
	Gas side	Liquid side																											
RXYCQ8	Ø15.9 → Ø19.1	Ø9.5																											
RXYCQ10	Ø19.1 → Ø22.2	Ø9.5 → Ø12.7																											
RXYCQ12	Ø22.2 → Ø25.4 ^(a)	Ø12.7 → Ø15.9																											
RXYCQ14~16	Ø28.6	Ø15.9 → Ø19.1																											
RXYCQ18, 20, 24	Ø28.6 → Ø31.8 ^(a)	Ø19.1 → Ø22.2																											
RXYCQ28	Ø34.9	—																											
RXYCQ32, 38	Ø34.9 → Ø38.1 ^(a)	—																											
RXYCQ40	Ø41.3	—																											

How to calculate the additional refrigerant to be charged Additional refrigerant to be charged R (kg) R should be rounded off in units of 0.1 kg	$R = [(X1 \times \text{Ø}22.2) \times 0.37] + [(X2 \times \text{Ø}19.1) \times 0.26] + [(X3 \times \text{Ø}15.9) \times 0.18] + [(X4 \times \text{Ø}12.7) \times 0.12] + [(X5 \times \text{Ø}9.5) \times 0.059] + [(X6 \times \text{Ø}6.4) \times 0.022] + A$ <p>X_{1~6} = Total length (m) of liquid piping size at Øa A = Weight according to table</p>	Example for refrigerant branch using refnet joint and refnet header for RXYCQ38 (1x16 + 1x20) If the outdoor unit is RXYCQ18 and the piping lengths are as below																																																
Note 1 		<table border="1"> <thead> <tr> <th></th> <th>a</th> <th>b</th> <th>c</th> <th>d</th> <th>e</th> <th>f</th> <th>g</th> <th>h</th> <th>i</th> <th>j</th> <th>k</th> </tr> </thead> <tbody> <tr> <td>1</td> <td>Ø19.1x30 m</td> <td>Ø9.5x10 m</td> <td>Ø6.4x10 m</td> <td>Ø6.4x10 m</td> <td>Ø6.4x10 m</td> <td>Ø6.4x10 m</td> <td>Ø6.4x10 m</td> <td>Ø6.4x20 m</td> <td>Ø6.4x9 m</td> <td>Ø6.4x10 m</td> <td>Ø6.4x9 m</td> </tr> <tr> <td>2</td> <td>Ø15.9x10 m</td> <td>Ø9.5x10 m</td> <td>Ø6.4x20 m</td> <td>Ø6.4x20 m</td> <td>Ø6.4x20 m</td> <td>Ø6.4x20 m</td> <td>Ø6.4x20 m</td> <td>Ø6.4x20 m</td> <td>Ø6.4x9 m</td> <td>Ø6.4x10 m</td> <td>Ø6.4x9 m</td> </tr> <tr> <td>3</td> <td>Ø9.5x10 m</td> <td>Ø9.5x10 m</td> <td>Ø6.4x20 m</td> <td>Ø6.4x20 m</td> <td>Ø6.4x20 m</td> <td>Ø6.4x20 m</td> <td>Ø6.4x20 m</td> <td>Ø6.4x20 m</td> <td>Ø6.4x9 m</td> <td>Ø6.4x10 m</td> <td>Ø6.4x9 m</td> </tr> </tbody> </table> <p>R = [30x0.26]+[10x0.18]+[10x0.12]+[40x0.059]+[49x0.022]+2 = 16.238 ⇒ R = 16.2 kg</p>		a	b	c	d	e	f	g	h	i	j	k	1	Ø19.1x30 m	Ø9.5x10 m	Ø6.4x10 m	Ø6.4x10 m	Ø6.4x10 m	Ø6.4x10 m	Ø6.4x10 m	Ø6.4x20 m	Ø6.4x9 m	Ø6.4x10 m	Ø6.4x9 m	2	Ø15.9x10 m	Ø9.5x10 m	Ø6.4x20 m	Ø6.4x20 m	Ø6.4x20 m	Ø6.4x20 m	Ø6.4x20 m	Ø6.4x20 m	Ø6.4x9 m	Ø6.4x10 m	Ø6.4x9 m	3	Ø9.5x10 m	Ø9.5x10 m	Ø6.4x20 m	Ø6.4x20 m	Ø6.4x20 m	Ø6.4x20 m	Ø6.4x20 m	Ø6.4x20 m	Ø6.4x9 m	Ø6.4x10 m	Ø6.4x9 m
	a	b	c	d	e	f	g	h	i	j	k																																							
1	Ø19.1x30 m	Ø9.5x10 m	Ø6.4x10 m	Ø6.4x10 m	Ø6.4x10 m	Ø6.4x10 m	Ø6.4x10 m	Ø6.4x20 m	Ø6.4x9 m	Ø6.4x10 m	Ø6.4x9 m																																							
2	Ø15.9x10 m	Ø9.5x10 m	Ø6.4x20 m	Ø6.4x20 m	Ø6.4x20 m	Ø6.4x20 m	Ø6.4x20 m	Ø6.4x20 m	Ø6.4x9 m	Ø6.4x10 m	Ø6.4x9 m																																							
3	Ø9.5x10 m	Ø9.5x10 m	Ø6.4x20 m	Ø6.4x20 m	Ø6.4x20 m	Ø6.4x20 m	Ø6.4x20 m	Ø6.4x20 m	Ø6.4x9 m	Ø6.4x10 m	Ø6.4x9 m																																							

Note 2 	Required conditions Allowable length after the first refrigerant branch kit to indoor units is 40 m or less, however it can be extended up to 90 m if all the following conditions are fulfilled.	Example drawings indoor unit 8: b+c+d+e+f+g+p+q=90 m increase the pipe size of b, c, d, e, f, g
Note 1 	Required conditions It is necessary to increase the pipe size of the liquid and the gas pipe if the pipe length between the first and the final branch kit is over 40 m (reducers must be procured on site). If the increased pipe size is larger than the pipe size of the main pipe, then the pipe size of the main pipe needs to be increased as well.	Example drawings indoor unit 8: a+b*2+c*2+d*2+e*2+f*2+g*2+h+h+h+h+h+h+n+n+p+s=300 m h, i, j, ... p=40 m
Note 2 	Required conditions For calculation of total extension length, the actual length of above pipes must be doubled. (except main pipe and the pipes that not increase the pipe size) Indoor unit to the nearest branch kit ≤40 m The difference between the distance of the outdoor unit to the farthest indoor unit and the distance of the outdoor unit to the nearest indoor unit ≤40 m	Example drawings 1 Outdoor unit 2 Refnet joints (a-g) 3 Indoor units (1-8)

Note 2 	If the pipe size above the refnet header is Ø34.9 or more, KHRQ22M75H is required.
-------------------	--

3. LEAK TEST AND VACUUM DRYING

Refer to chapter "7. Leak test and vacuum drying" of the installation manual.

After connecting the field piping, perform the following inspections.

1 Preparations

Connect a nitrogen tank, a cooling tank, and a vacuum pump to the outdoor unit and perform the airtightness test and the vacuum drying. The stop valve and valves A and B should be open and closed as shown in the table below when performing the airtightness test and vacuum drying.

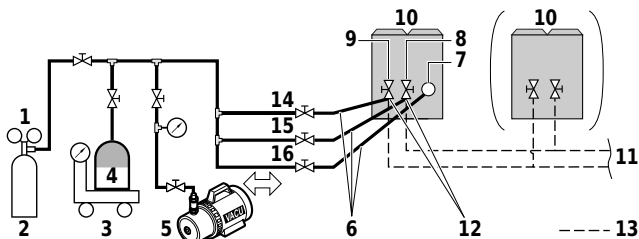

- 1 Pressure reducing valve
- 2 Nitrogen
- 3 Measuring instrument
- 4 Tank (siphon system)
- 5 Vacuum pump
- 6 Charge hose
- 7 Service port for adding refrigerant
- 8 Liquid line stop valve
- 9 Gas line stop valve
- 10 Outdoor unit
- 11 To indoor unit
- 12 Stop valve service port
- 13 Dotted lines represent on site piping
- 14 Valve B
- 15 Valve C
- 16 Valve A

State of the valves A and B and the stop valve	Valve A	Valve B	Valve C	Liquid side stop valve	Gas side stop valve
Performing the airtightness test and vacuum drying (Valve A must always be shut. Otherwise the refrigerant in the unit will pour out.)	Close	Open	Open	Close	Close

2 Airtightness test and vacuum drying

4. FIELD WIRING

Refer to chapter "8. Field wiring" of the installation manual.

4.1. Power circuit and cable requirements

Refer to chapter "8.3. Power circuit and cable requirements" of the installation manual.

	Phase and frequency	Voltage	Minimum circuit ampere	Recommended fuses	Transmission line section
RXYCQ24	3N~ 50 Hz	380~ 415V	41.2 A	50 A	0.75~1.25 mm ²
RXYCQ28	3N~ 50 Hz	380~ 415V	50.0 A	63 A	0.75~1.25 mm ²
RXYCQ32	3N~ 50 Hz	380~ 415V	54.2 A	63 A	0.75~1.25 mm ²
RXYCQ38	3N~ 50 Hz	380~ 415V	64.0 A	80 A	0.75~1.25 mm ²
RXYCQ40	3N~ 50 Hz	380~ 415V	65.0 A	80 A	0.75~1.25 mm ²

	Z _{max} (Ω)	Minimum S _{sc} value
RXYCQ24 = RXYCQ10 + RXYCQ14	0.27	1759 kVA
RXYCQ28 = RXYCQ10 + RXYCQ18	0.24	1783 kVA
RXYCQ32 = RXYCQ14 + RXYCQ18	0.23	1722 kVA
RXYCQ38 = RXYCQ18 + RXYCQ20	0.22	1751 kVA
RXYCQ40 = RXYCQ20 + RXYCQ20	0.22	1756 kVA

4.2. System examples

Refer to chapter "8.5. System examples" of the installation manual.

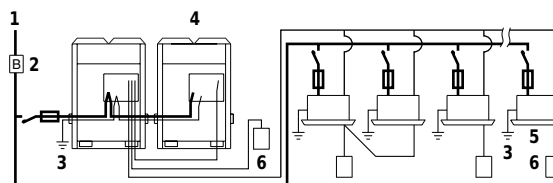

- 1 Field power supply
- 2 Main switch
- 3 Earth leakage breaker
- 4 Outdoor unit
- 5 Indoor unit
- 6 Remote controller
- Power supply wiring (sheathed cable) (230 V)
- Transmission wiring (sheathed cable) (16 V)

4.3. Field line connection: transmission wiring and cool/heat selection

Refer to chapter "8.7.Field line connection: transmission wiring and cool/heat selection" of the installation manual.

In case of RXYCQ24~40

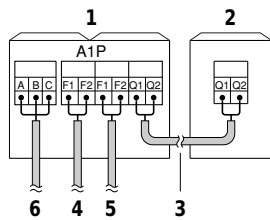

- 1 Unit A (Master unit)
- 2 Unit B (Slave unit)
- 3 To slave unit(s)
- 4 To indoor unit
- 5 To outdoor unit
- 6 To cool/heat selector

NOTE RXYCQ8 can not install the multi unit transmission wiring. Run will not be successful if the wiring is connected to Q1-Q2 (TO MULTI UNIT) terminal.

- The interconnecting wiring between the outdoor units in the same piping system must be connected to the Q1/Q2 (Out Multi) terminals. Connecting the wires to the F1/F2 (Out-Out) terminals results in system malfunction.
- The base unit is the outdoor unit to which the interconnecting wiring for the indoor units is connected.

Fixing transmission wiring

Inside switchbox

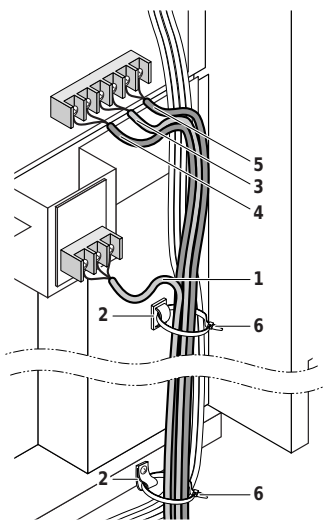

- 1 Heating/cooling switching remote control cord (when a heating/cooling switch remote control (optional) is connected) (ABC).
- 2 Fix to the indicated plastic brackets using field supplied clamping material.
- 3 Wiring between the units (Outdoor - outdoor) (F1+F2 right)
- 4 Wiring between the units (Indoor - outdoor) (F1+F2 left)
- 5 Wiring for multi connection (only for RXYCQ24~40)(Q1+Q2)
- 6 Plastic bracket

5. ADDITIONAL REFRIGERANT CHARGE

Refer to chapter "11.5.Additional refrigerant charge" of the installation manual.

Charging method

As explained during vacuum drying method, once vacuum drying is finished, additional refrigerant charging can start.

Follow the steps as described below.

- 1 Calculate the amount of refrigerant to be added using the formula mentioned in "How to calculate the additional refrigerant to be charged".

The first 10 kg of refrigerant can be charged without outdoor unit operation. If the additional refrigerant amount is smaller than 10 kg, perform the precharging procedure as explained in step 2 below. If the additional refrigerant charge is larger than 10 kg, perform step 2 and perform step 3 till the end of the procedure.

- 2 Precharging can be done without compressor running by connecting the refrigerant bottle only to the liquid stop valve.

Make sure that the stop valves are closed:

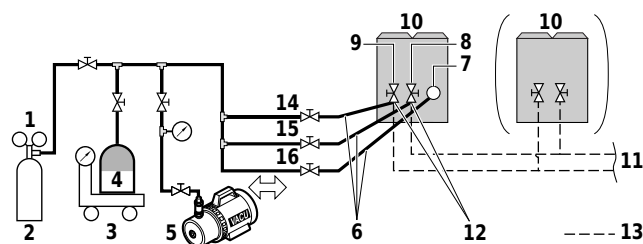

- 1 Pressure reducing valve
- 2 Nitrogen
- 3 Measuring instrument
- 4 Tank (siphon system)
- 5 Vacuum pump
- 6 Charge hose
- 7 Service port for adding refrigerant
- 8 Liquid line stop valve
- 9 Gas line stop valve
- 10 Outdoor unit
- 11 To indoor unit
- 12 Stop valve service port
- 13 Dotted lines represent on site piping
- 14 Valve B
- 15 Valve C
- 16 Valve A

- 3 If the total amount of refrigerant could not be charged by precharging, then connect the refrigerant bottle to the refrigerant charging port as described in the figure above.

- 4 Make sure to open all 3 stop valves of the outdoor unit (see "11.3.Stop valve operation procedure" in the installation manual).

- 5 Turn on the power of the indoor units and outdoor unit.
To be able to do this operation, the outdoor unit should be set in mode 2.

- 6 Push the **BS1 MODE** button for 5 sec, the H1P LED is on ☀.

- 7 Push the **BS2 SET** button 20 times until following LED combination is reached:

H1P	H2P	H3P	H4P	H5P	H6P	H7P
☀	●	☀	●	☀	●	●

- 8 Push the **BS3 RETURN** button to confirm setting 2-20 above.
- 9 Push the **BS2 SET** button to change the charge mode from OFF (OFF) to ON (ON). LED indication should change as follows

	H1P	H2P	H3P	H4P	H5P	H6P	H7P
OFF (a)	☀	●	●	●	●	●	☀
ON	☀	●	●	●	●	☀	●

(a) This setting = factory setting

- 10 Push the **BS3 RETURN** button and the setting is defined.
- 11 Push the **BS3 RETURN** button again, and the refrigerant charging operation will start.
- 12 After charging the specified quantity of refrigerant, press the **BS3 RETURN** button to stop the operation.

INFORMATION

The operation will automatically stop within 30 minutes. If charging is not completed after 30 minutes, perform the additional refrigerant charging operation again.

Checks after adding refrigerant

- Are the stop valves for liquid and gas open?
- Is the amount of refrigerant, that has been added, recorded on the refrigerant charge label?

NOTICE

- Make sure to open the stop valves after charging the refrigerant.
- Operating with the stop valves closed will damage the compressor.

6. BEFORE OPERATION

Refer to chapter "12.Before operation" of the installation manual.

6.1. Field setting

Refer to chapter "12.3.Field setting" of the installation manual.

Check operation procedure

LED display (Default status before delivery)	Micro-computer operation monitor HAP	Mode H1P	Ready/Error H2P	Cooling/Heating changeover			Low noise H6P	Demand H7P	Multi H8P
				Individual H3P	Bulk (master) H4P	Bulk (slave) H5P			
Single outdoor unit system	☀	●	●	☀	●	●	●	●	●
Multiple outdoor unit system	Master unit ^(a)	☀	●	☀	●	●	●	●	☀
	Slave unit 1 ^(a)	☀	●	●	●	●	●	●	☀

(a) The state of the H8P (multi) LED in a multi-system shows which unit is the master unit (☀) or slave unit 1 (☀). Only the master unit is connected to the indoor units with interunit wiring.

