

DAIKIN



INSTALLATION MANUAL

Packaged air-cooled water chillers

EWYQ080DAYN
EWYQ100DAYN
EWYQ130DAYN
EWYQ150DAYN
EWYQ180DAYN
EWYQ210DAYN
EWYQ230DAYN
EWYQ250DAYN

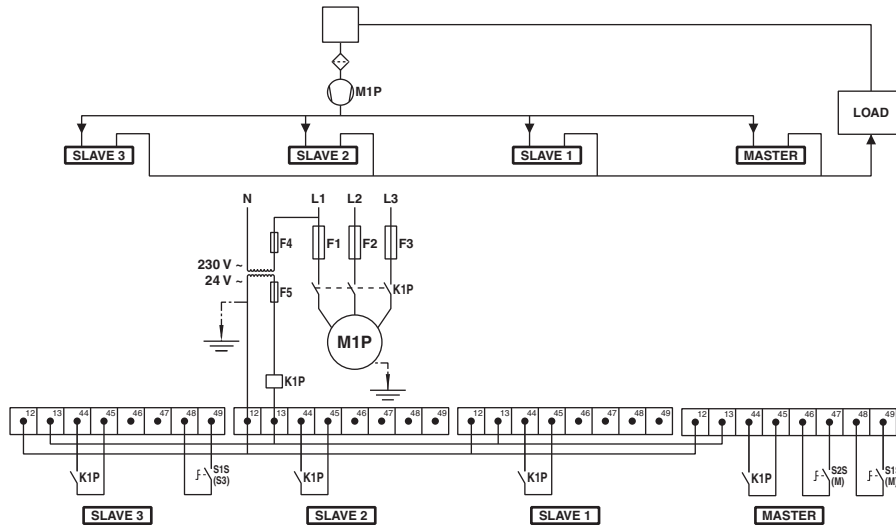

1

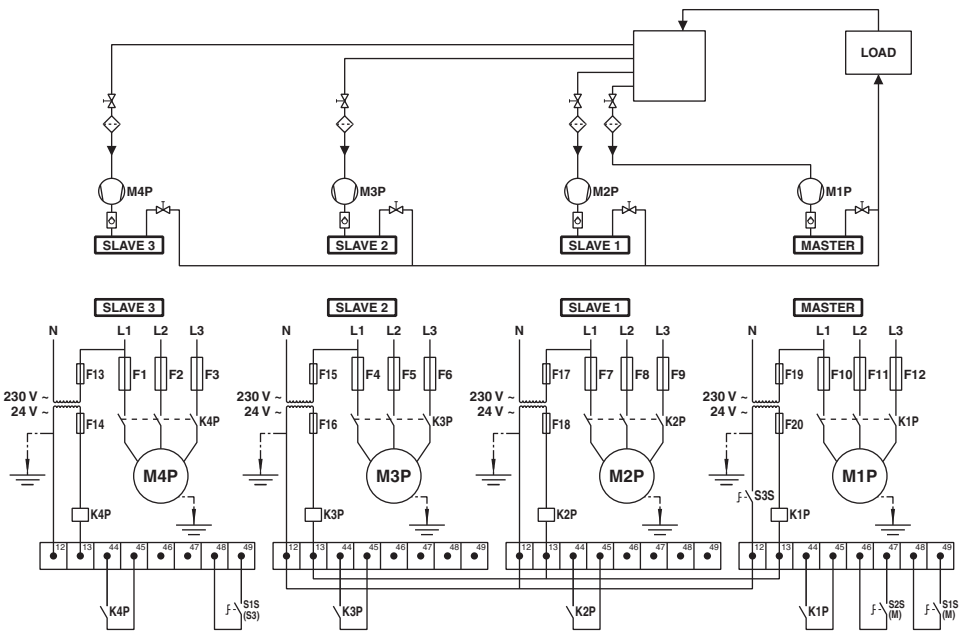

2

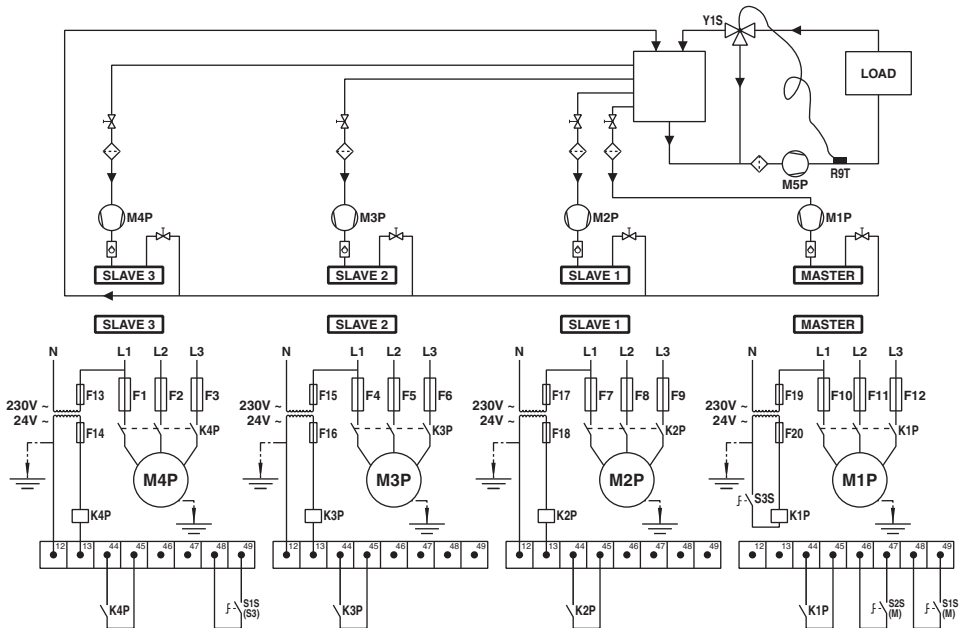

3

CONTENTS

	Page
Introduction.....	1
Technical specifications.....	1
Electrical specifications.....	1
Options and features.....	1
Operation range.....	2
Operation range.....	2
Main components.....	2
Selection of location.....	2
Inspecting and handling the unit.....	3
Unpacking and placing the unit.....	3
Important information regarding the refrigerant used.....	4
Checking the water circuit.....	4
Connecting the water circuit.....	4
Water charge, flow and quality.....	4
Charging water.....	5
Piping insulation.....	6
Field wiring.....	6
Parts table.....	6
Power circuit and cable requirements.....	7
Connection of the air-cooled water chiller power supply.....	7
Interconnection cables.....	7
Connecting field wiring.....	7
Connection and setup of a DICN system (option kit EKACPG).....	8
Cable for remote digital controller (option kit EKRUPG).....	8
Before starting.....	9
How to continue.....	11

Thank you for purchasing this Daikin air conditioner.

The original instructions are written in English. All other languages are translations of the original instructions.



READ THIS MANUAL ATTENTIVELY BEFORE STARTING UP THE UNIT. DO NOT THROW IT AWAY. KEEP IT IN YOUR FILES FOR FUTURE REFERENCE.

IMPROPER INSTALLATION OR ATTACHMENT OF EQUIPMENT OR ACCESSORIES COULD RESULT IN ELECTRIC SHOCK, SHORT-CIRCUIT, LEAKS, FIRE OR OTHER DAMAGE TO THE EQUIPMENT. BE SURE ONLY TO USE ACCESSORIES MADE BY DAIKIN WHICH ARE SPECIFICALLY DESIGNED FOR USE WITH THE EQUIPMENT AND HAVE THEM INSTALLED BY A PROFESSIONAL.

IF UNSURE OF INSTALLATION PROCEDURES OR USE, ALWAYS CONTACT YOUR DAIKIN DEALER FOR ADVICE AND INFORMATION.

INTRODUCTION

The Daikin EWYQ-DAYN air-cooled water chillers are designed for outdoor installation and used for cooling and heating applications. The units are available in 8 standard sizes with nominal cooling capacities ranging from 80 to 250 kW.

The EWYQ units can be combined with Daikin fan coil units or air handling units for air conditioning purposes. They can also be used for supplying chilled water for process cooling.

The present installation manual describes the procedures for unpacking, installing and connecting the EWYQ units.

Technical specifications⁽¹⁾

Model EWYQ	080	100	130
Refrigerant	R410A		
Dimensions HxWxD (mm)	2311x2000x2631		
Weight			
• machine weight (kg)	1400	1450	1550
• operation weight (kg)	1415	1465	1567
Connections			
• chilled water inlet and outlet	3" OD (76.1 mm OD)		

Model EWYQ	150	180	210
Refrigerant	R410A		
Dimensions HxWxD (mm)	2311x2000x2631	2311x2000x3081	
Weight			
• machine weight (kg)	1600	1850	1900
• operation weight (kg)	1619	1875	1927
Connections			
• chilled water inlet and outlet	3" OD (76.1 mm OD)		

Model EWYQ	230	250
Refrigerant	R410A	
Dimensions HxWxD (mm)	2311x2000x4833	
Weight		
• machine weight (kg)	3200	3300
• operation weight (kg)	3239	3342
Connections		
• chilled water inlet and outlet	3" (88.9 mm OD)	

Electrical specifications⁽¹⁾

Model EWYQ	080~250
Power circuit	YN
• Phase	3~
• Frequency (Hz)	50
• Voltage (V)	400
• Voltage tolerance (%)	±10

Options and features⁽¹⁾

Options

- Suction stop valve, liquid stop valve, discharge stop valve (OP12)
- Ampere and voltmeter readout on controller (OP57)
- Dual pressure relief valve (OP03)
- Condenser protection grills (OPCG)
- Inverter fans (OPIF)
- Low noise operation (OPLN = OPIF + compressor housing)
- Single pump (OPSP)
- High static pump (OPHP)
- Twin pump (OPTP)
- Heater tape(s) (OP10)
- Glycol application for leaving evaporator water down to -10°C (OPZL)
- High static fans (OPHF)
- Address card (EKACPG) including
 - Daikin Integrated Chiller Network (DICN)
 - Serial communication (MODBUS)
- Remote user interface (EKRUPG)
- Single pump contactor (OPSC)
- Twin pump contactor (OPTC)
- Buffer tank (OPBT)

(1) Refer to the operation manual or engineering data book for the complete list of specifications, options and features.

Features

- Factory mounted main switch
- Factory mounted flow switch and water filter
- Read out of refrigerant pressures (high and low) via controller
- High (partial load) efficiency
- Electronic expansion valve + sight glass with moisture indication
- Voltage free contacts
 - general operation
 - pump contact
 - second pump contact for dual pump function
 - safety + warning signal (normal open or normal closed contact)
 - 100% capacity signal, full capacity signal
 - operation circuit 1
 - operation circuit 2 (only for EWYQ130~250)
- Remote inputs
 - remote on-off
 - dual setpoint
 - capacity limitation (different settings possible)
 - low noise (only for option OPIF)
 - free cooling signal
 - fan forced on signal
- Changeable analogue inputs
 - floating setpoint (mA, V, NTC)
 - additional water temperature measurement (NTC)
- Changeable analogue outputs
 - unit capacity (mA, V)

OPERATION RANGE

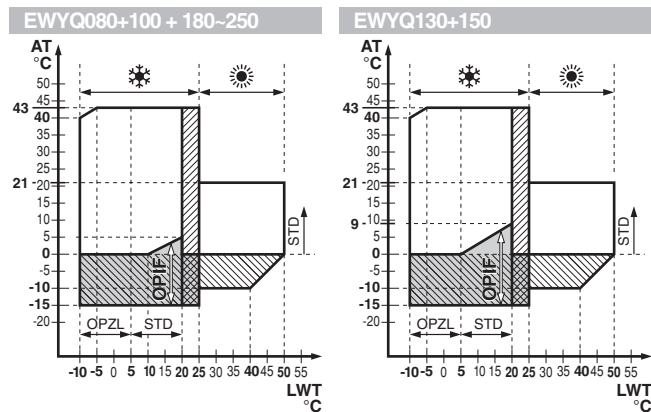

- | | | | |
|-------------|--|--|---|
| | Cooling mode | | Pull down operation area |
| | Heating mode | | Continuous operation area |
| AT | Ambient temperature | | Protect the water circuit against freezing by heater tape (OP10) or by filling up the system with a glycol solution |
| LWT | Leaving evaporator water temperature | | Option inverter fans (OPIF) |
| STD | Standard unit | | |
| OPIF | Option inverter fans | | |
| OPZL | Option glycol application for leaving evaporator water down to -10°C | | |

MAIN COMPONENTS (refer to the outlook diagram supplied with the unit)

- | | | | |
|-----------|---|-----------|--|
| 1 | Evaporator (in cooling mode) or condenser (in heating mode) | 18 | Digital display controller (inside switchbox) |
| 2 | Condenser (in cooling mode) or evaporator (in heating mode) | 19 | Field wiring intake |
| 3 | Compressor | 20 | Main isolator switch |
| 4 | Electronic expansion valve + sight glass with moisture indication | 21 | Transport beam |
| 5 | Discharge stop valve (optional) | 22 | Flow switch |
| 6 | Suction stop valve (optional) | 23 | Fan |
| 7 | Liquid stop valve (optional) | 24 | Safety valve |
| 8 | Chilled water in (Victaulic® coupling) | 25 | High pressure sensor |
| 9 | Chilled water out (Victaulic® coupling) | 26 | Low pressure sensor |
| 10 | Water drain evaporator | 27 | High pressure switch |
| 11 | Air purge | 28 | Oil sight glass |
| 12 | Leaving water temperature sensor (R3T) | 29 | Water filter |
| 13 | Entering water temperature sensor (R2T) | 30 | Frame |
| 14 | Ambient temperature sensor (R1T) | 31 | 4-way valve |
| 15 | Drier + charge valve | 32 | Liquid receiver |
| 16 | Power supply intake | 33 | Pump (optional) |
| 17 | Switchbox | 34 | Buffer tank (optional) |
| | | 35 | Expansion vessel (optional) |
| | | 36 | Water stop valves (optional) |
| | | 37 | Buffer tank drain valve (optional) |
| | | 38 | Regulating valve (optional) |
| | | 39 | Water safety valve (optional) |
| | | 40 | Pressure gauge (optional) |
| | | 41 | Eye bolt for lifting the unit (only for EWYQ080~210) |

- Required space around the unit for service and air intake
- Centre of gravity

SELECTION OF LOCATION

This is a class A product. In a domestic environment this product may cause radio interference in which case the user may be required to take adequate measures.

Make sure that the unit is not accessible by the general public.

The units are designed either for roof mounting or ground level mounting and should be installed in a location that meets the following requirements:

- 1 The foundation is strong enough to support the weight of the unit and the floor is flat to prevent vibrations and noise generation.
- 2 The space around the unit is adequate for servicing and the minimum space for air inlet and air outlet is available (refer to the paragraph "Description" in the operation manual).
If several units are being installed side by side, the minimum service space between these must be taken into account.
- 3 There is no danger of fire due to leakage of inflammable gas.
- 4 The equipment is not intended for use in a potentially explosive atmosphere.
- 5 Ensure that water cannot cause any damage to the location by adding water drains to the foundation and prevent water traps in the construction.
- 6 Select the location of the unit in such a way that neither the discharged air nor the sound generated by the unit disturb anyone.
- 7 Make sure that the air inlet and outlet of the unit are not positioned towards the main wind direction. Frontal wind will disturb the operation of the unit. If necessary, use a windscreen to block the wind.
- 8 In heavy snowfall areas, select an installation site where snow will not affect operation of the unit.

INSPECTING AND HANDLING THE UNIT

At delivery, the unit should be checked and any damage should be reported immediately to the carrier claims agent.

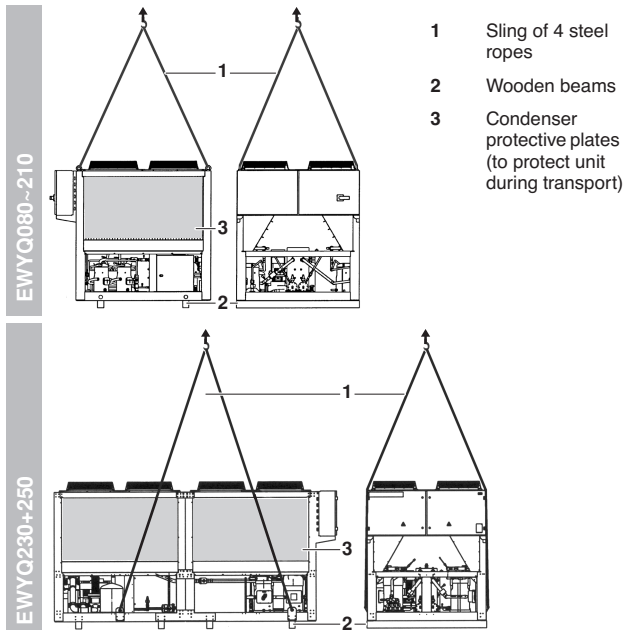

When handling the unit, take into account the following:

- Lift the unit preferably with a crane and a sling of 4 steel ropes in accordance with the instruction sticker on the unit.
 - For EWYQ080~210: The length of the individual steel ropes must be 3 m minimum each. Make sure the steel ropes are attached onto the foreseen eyebolts at the top of the unit.
 - For EWYQ230+250: The length of the individual steel ropes must be 6 m minimum each. Make sure the steel ropes are attached onto the foreseen yellow lifting plates at the bottom of the unit.
- When lifting the unit with a crane pay attention to the position of the unit's centre of gravity.
- Bring the unit as close as possible to its final installation position in its original package to prevent damage during transport.

UNPACKING AND PLACING THE UNIT

- Remove the wooden beams from the unit.
- Install vibration mountings in case of a roof-mounted unit or other installation where noise and vibration might be an impediment.
- Set the unit on a solid and level foundation.

Roof mounted:	The unit must be installed on steel-channel or I-beam frame to support the unit on the roof, or it can be installed on a concrete base.
Ground level mounted:	The unit must be installed on a solid base. It is recommended to fix the unit on a concrete base with anchor bolts.

Ground level mounting

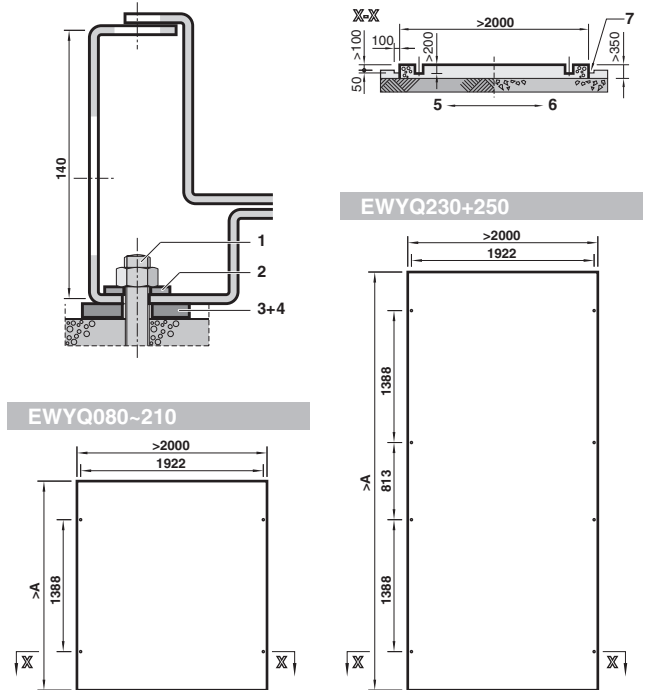

- Fix anchor bolts (1) into the concrete foundation. When finally fixing the unit by means of these anchor bolts, make sure that the washers for channel DIN434 (2), and both field supplied rubber plates (3) and field supplied raw cork or rubber sheets (4) for better vibration protection, are installed as indicated.
- The concrete foundation should approximately be 100 mm higher than the floor level for ease of plumbing work and better drain.

Model	A	anchor bolt size	Qty
EWYQ080	2200	M16x200	4
EWYQ100	2200	M16x200	4
EWYQ130	2200	M16x200	4
EWYQ150	2200	M16x200	4
EWYQ180	2650	M16x200	4
EWYQ210	2650	M16x200	4
EWYQ230	4200	M16x200	8
EWYQ250	4200	M16x200	8

- Make sure that the foundation surface is even and flat.



- The measurement tabulated is based on the fact the base is made in the ground (5) or on a concrete floor (6). In case the base is made on a rigid floor, it is possible to include thickness of concrete floor in that of the base.
- In case a base is made on concrete floor, make sure to provide a ditch (7) as shown. It is important to extract drainage regardless of whether a base is made in the ground or on the concrete floor (ditch-sewerage).
- Ingredient ratio of the concrete is: cement 1, sand 2 and gravel 3. Insert iron bars of Ø10 mm at every interval of 300 mm. The edge of the concrete base should be planed.

- Remove the condenser protective plates from the unit.
- For EWYQ230+250 only: Remove the yellow lifting plates from the unit.
- Remove the 2 yellow transport fixation stays from the compressors.
- Remove the fixation straps from the liquid receivers.

IMPORTANT INFORMATION REGARDING THE REFRIGERANT USED

This product contains fluorinated greenhouse gases covered by the Kyoto Protocol. Do not vent gases into the atmosphere.

Refrigerant type: R410A
GWP⁽¹⁾ value: 1975

⁽¹⁾ GWP = global warming potential

The refrigerant quantity is indicated on the unit name plate.

CHECKING THE WATER CIRCUIT

The units are equipped with a water inlet and water outlet for connection to a water circuit. This circuit must be provided by a licensed technician and must comply with all relevant European and national regulations.

Before continuing the installation of the unit, check the following points:

Only for EWYQ*DAYN (without option OPSP, OPTP or OPHP)

- A circulation pump must be provided in such a way that it discharges the water directly into the water heat exchanger.
- Provide adequate safeguards in the water circuit to make sure that the water pressure will never exceed the maximum allowable working pressure (10 bar).
- Shut-off valves must be provided at the unit so that normal servicing can be accomplished without draining the system.

For all models

- Drain taps must be provided at all low points of the system to permit complete drainage of the circuit during maintenance or in case of shut down. A drain plug is provided to drain the water from the chiller water system.
- Air vents must be provided at all high points of the system. The vents should be located at points which are easily accessible for servicing. An automatic air purge is provided on the chiller water system.
- Take care that the components installed in the field piping can withstand at least the sum of opening pressure of the safety valve + the static height of the pump.

CONNECTING THE WATER CIRCUIT

Water connections must be made in accordance with the outlook diagram delivered with the unit, respecting the water in- and outlet.



Be careful not to deform the unit piping by using excessive force when connecting the piping. Deformation of the piping can cause the unit to malfunction.

If air, moisture or dust gets in the water circuit, problems may occur. Therefore, always take into account the following when connecting the water circuit:

- 1 Use clean pipes only.
- 2 Hold the pipe end downwards when removing burrs.
- 3 Cover the pipe end when inserting it through a wall so that no dust and dirt enter.

WATER CHARGE, FLOW AND QUALITY

For all models

To assure proper operation of the unit a minimum water volume is required in the system and the water flow through the evaporator must be within the operation range as specified in the table.

■ Cooling mode

Unit	Minimum water volume (l) ^(*)	Minimum water flow	Maximum water flow
EWYQ080	690/a	110 l/min	441 l/min
EWYQ100	896/a	143 l/min	573 l/min
EWYQ130	609/a	195 l/min	780 l/min
EWYQ150	649/a	208 l/min	831 l/min
EWYQ180	820/a	262 l/min	1049 l/min
EWYQ210	945/a	302 l/min	1210 l/min
EWYQ230	1030/a	330 l/min	1319 l/min
EWYQ250	1120/a	358 l/min	1433 l/min

^(*) a = cooling temperature difference (refer to "Defining the thermostat settings" on page 11)

■ Heating mode

Unit	Minimum water volume (l) ^(*)	Minimum water flow	Maximum water flow
EWYQ080	786/a	126 l/min	503 l/min
EWYQ100	1021/a	163 l/min	654 l/min
EWYQ130	667/a	214 l/min	854 l/min
EWYQ150	739/a	237 l/min	946 l/min
EWYQ180	891/a	285 l/min	1141 l/min
EWYQ210	1008/a	323 l/min	1290 l/min
EWYQ230	1120/a	358 l/min	1433 l/min
EWYQ250	1232/a	394 l/min	1577 l/min

^(*) a = heating temperature difference (refer to "Defining the thermostat settings" on page 11)

Only for models with option OPSP, OPTP or OPHP

Maximum allowed installation height in function of the water volume

Make sure to respect following limitations:

EWYQ	080~210	230+250
Volume expansion vessel	35 l	50 l

If the EWYQ unit is installed at the highest point of the system, then there is no height difference to be considered.

If the EWYQ unit is placed on a height level other than the highest point, refer to the figure in "Charging water" on page 5 to read the maximum allowed height difference in function of the water volume.

- e.g. for EWYQ080~210: If water volume=650 l, the maximum allowed installation height difference is 9 m.
- e.g. for EWYQ230+250: If water volume=650 l, the maximum allowed installation height difference is 13 m.

Setting the pre-pressure of the expansion vessel

The pre-pressure (Pg) on the expansion vessel has to be set before filling the system with water or water/glycol solution in function of the maximum installation height difference (H).

Use dry compressed air or nitrogen for this operation.

The pre-pressure (Pg) to be set is calculated as below:

$$Pg = (H/10 + 0.3) \text{ bar}$$

H = Maximum installation height of the circuit above the EWYQ unit (m)

NOTE



- For EWYQ080~210: If H ≤ 12 m and the water volume ≤ 520 l, we recommend not to change the factory setting of the pre-pressure (= 1.5 bar)
- For EWYQ230+250: If H ≤ 12 m and the water volume ≤ 750 l, we recommend not to change the factory setting of the pre-pressure (= 1.5 bar)

Water quality specifications

The water quality must be in accordance with the specifications listed in the table below.

		circulating water	supply water	tendency if out of criteria
Items to be controlled				
pH	at 25°C	6.8~8.0	6.8~8.0	corrosion+scale
Electrical conductivity	[mS/m] at 25°C	<40	<30	corrosion+scale
Chloride ion	[mg Cl ⁻ /l]	<50	<50	corrosion
Sulphate ion	[mg SO ₄ ²⁻ /l]	<50	<50	corrosion
M-alkalinity (pH4.8)	[mg CaCO ₃ /l]	<50	<50	scale
Total hardness	[mg CaCO ₃ /l]	<70	<70	scale
Calcium hardness	[mg CaCO ₃ /l]	<50	<50	scale
Silica ion	[mg SiO ₂ /l]	<30	<30	scale
Items to be referred to				
Iron	[mg Fe/l]	<1.0	<0.3	corrosion+scale
Copper	[mg Cu/l]	<1.0	<0.1	corrosion
Sulphide ion	[mg S ²⁻ /l]	not detectable	not detectable	corrosion
Ammonium ion	[mg NH ₄ ⁺ /l]	<1.0	<0.1	corrosion
Remaining chloride	[mg Cl/l]	<0.3	<0.3	corrosion
Free carbide	[mg CO ₂ /l]	<4.0	<4.0	corrosion
Stability index	—	—	—	corrosion+scale



The chillers are only to be used in a closed water system. Application in an open water circuit can lead to excessive corrosion of the water piping.

NOTE



Provide adequate safeguards in the water circuit to make sure that the water pressure will never exceed the maximum allowable working pressure. For models with option OPSP, OPTP or OPHP, also refer to "Setting the pre-pressure of the expansion vessel" on page 4.



If the water system is drained during some period, rinse out the pump chamber with demineralised water. This to prevent the impeller from being blocked by dried impurities.

To do this, use the drain tap of the pump. Fill and empty the pump a few times until the removed water is completely clear. Keep the connections closed to prevent corrosion and dirt entering the water system.

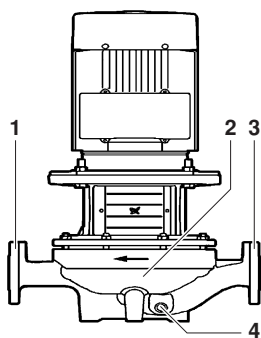

- 1 Water out
- 2 Impeller
- 3 Water in
- 4 Drain tap



Use of glycol is allowed, but the amount should not exceed 40% of the volume. A higher amount of glycol may cause damage to the hydraulic components.

Charging water

For all models

- 1 Connect the water supply to the drain and fill valve
- 2 Open the pressure regulating valve and shut-off valves (only for models with option OPSP, OPTP or OPHP)
- 3 Use the air purge valves on the unit and purge valves installed in the highest places in the circuit to remove all air when filling the system

Only for models with option OPSP, OPTP or OPHP

Water must be filled until the system reaches the required pressure (Pr). The pressure can be read on the manometer.

The value of the required water pressure (Pr) is depending on the total water volume in the system and the pressure in the expansion vessel (see previous chapter).

Refer to the figure – Required water pressure in function of water volume and pre-pressure (Pg):

EWYQ080~210 35 l

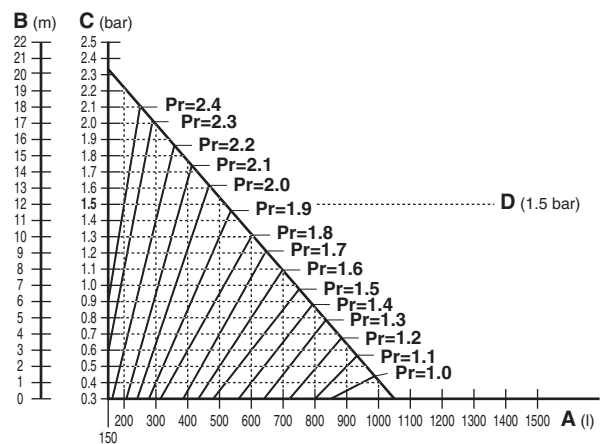

EWYQ230+250 50 l

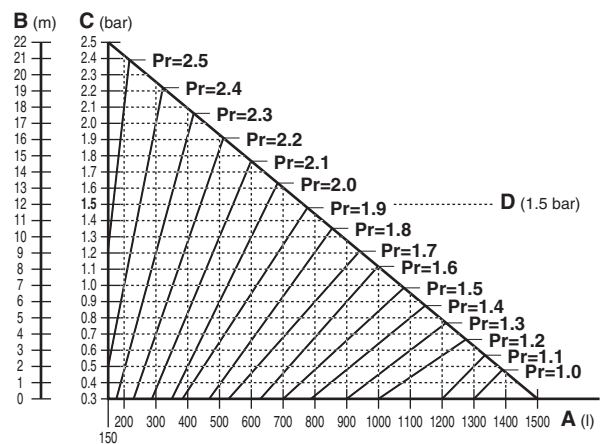

- A Water volume (l)
- B Installation height difference (m)
- C Pre-pressure (Pg)
- D Pre-pressure factory setting (1.5 bar)

1. Calculate the total water volume in the entire system corresponding with the expansion vessel.
2. Check in the figure above where the horizontal line of the set pre-pressure (Pg) cuts the vertical line of the system water volume.
3. At the cutting point, read the required water pressure (Pr) from the lines in the figure.

Example 1

in case of EWYQ080~210 unit

Total system water volume=300 l
 Highest point of circuit above the EWYQ unit=5 m
 $P_g=(5/10+0.3)=0.8$ bar
 $P_r=\pm 2.1$ bar

in case of EWYQ230+250 unit

Total system water volume=600 l
 Highest point of circuit above the EWYQ unit=5 m
 $P_g=(5/10+0.3)=0.8$ bar
 $P_r=\pm 1.9$ bar

NOTE  In this example it is allowed to keep the pre-pressure factory setting from 1.5 bar. In this case the initial water-pressure must be ± 2.2 bar

Example 2

in case of EWYQ080~210 unit

Total system water volume=600 l
 Highest point of circuit above the EWYQ unit=5 m
 $P_g=(5/10+0.3)=0.8$ bar
 $P_r=\pm 1.6$ bar

in case of EWYQ230+250 unit

Total system water volume=1000 l
 Highest point of circuit above the EWYQ unit=5 m
 $P_g=(5/10+0.3)=0.8$ bar
 $P_r=\pm 1.5$ bar

NOTE  In this example it is not allowed to keep the pre-pressure factory setting of 1.5 bar.

PIPING INSULATION

The complete water circuit, inclusive all piping, must be insulated to prevent condensation and reduction of the cooling capacity.

Protect the water piping against water freezing during winter period (e.g. by using an external field supplied heater tape or glycol solution).

NOTE  **■ In case a factory mounted heater tape (OP10) is installed:**
 Two terminals are foreseen in the switchbox on which an additional field supplied heater tape can be connected for preventing the water piping from freezing during the cold weather months. Refer to the wiring diagram supplied with the unit.

■ In case no heater tape is installed:
 The pump can be activated in low ambient conditions (refer to "Customization in the service menu" on page 9).

FIELD WIRING



All field wiring and components must be installed by a licensed electrician and must comply with relevant European and national regulations.

The field wiring must be carried out in accordance with the wiring diagram supplied with the unit and the instructions given below.

Be sure to use a dedicated power circuit. Never use a power supply shared by another appliance.

NOTE  Verify on the wiring diagram all electrical actions mentioned below, in order to understand the operation of the unit more deeply.

Parts table

Refer to the additional manual supplied with the unit for:

- Complete parts table
- Notes to go through

A02P..... **PCB communication (only for option EKACPG)
A4P.....PCB wired remote controller
A5P..... **PCB wired remote controller (only for option EKRUPG)
E5H	*.....Field heater
F1~F3..... #Main fuses
F4,F5..... #Fuse for heaters
H1P	*.....Indication lamp: alarm signal (default NO)
H2P~H6P ... *Indication lamp for changeable digital outputs
H11P,H12P ... *Indication lamp for operation compressor C11M, C12M
H21P,H22P ... *Indication lamp for operation compressor C21M, C22M (only for EWYQ130~250)
K1P..... ##Pump contactor (only for options OPSP, OPHP, OPSC, OPTP and OPTC)
K1S..... *Overcurrent relay pump (not for options OPSC, OPTC, OPSP, OPTP and OPHP)
K2P..... **Pump contactor (only for options OPTP and OPTC)
M1P	*.....Pump motor 1 (only for options OPSC, OPTC, OPSP, OPTP and OPHP)
M2P	*.....Pump motor 2 (only for options OPTP and OPTC)
R8T..... *Temperature sensor for changeable analogue input
S1MMain isolator switch
S1S~S5S.... *Switch for changeable digital input
S2M..... #Heater tape isolator switch
V2C	**.....Ferrite core (only for option EKACPG)
- - -Field wiring
①Several wiring possibilities
DIP switch (set on left position)

	Not included with standard unit	
	Not possible as option	Possible as option
Obligatory	#	##
Not obligatory	*	**

Power circuit and cable requirements

- 1 The electrical power supply to the unit must be arranged so that it can be switched on or off independently of the electrical supply to other items of the plant and equipment in general.
- 2 A power circuit must be provided for connection of the unit. This circuit must be protected with the required safety devices, i.e. a circuit breaker, a slow blow fuse on each phase and an earth leak detector (high speed type 100 mA rated). Recommended fuses are mentioned on the wiring diagram supplied with the unit. For a system with chillers in a DICN configuration, be sure to provide a separate power circuit for every chiller.



Switch off the main isolator switch before making any connections (switch off the circuit breaker, remove or switch off the fuses).

Connection of the air-cooled water chiller power supply

- 1 Using the appropriate cable, connect the power circuit to the L1, L2 and L3 terminals of the unit.
The power circuit must be connected to the terminals 2, 4 and 6 of the main isolator switch.
- 2 Connect the earth conductor (yellow/green) to the earthing terminal ⊕.

Interconnection cables

- **Only for models without option OPSP, OPTP, OPHP, OPSC or OPTC**



A pump interlock contact must be installed to prevent the unit from operating without water flow. A terminal is provided in the switchbox for the electrical connection of the interlock contact.

For units in a DICN configuration, every chiller can either have an individual circulation pump or 1 pump can discharge water in a distributor that leads water to several chillers.

In both cases, all units must be equipped with an interlock contact!

NOTE



Normally the unit will not operate if there is no flow thanks to the standard installed flow switch.

But as to have a double safety, you **must** install the pump interlock contact.

Operating the unit without flow will result in very severe damage to the unit (freezing of the evaporator).

- **Voltage free contacts (for all models)**

The controller is provided with voltage free contacts to indicate the status of the unit. These voltage free contacts can be wired as described on the wiring diagram.

- **Remote inputs (for all models)**

Besides the voltage free contacts, there are also possibilities to install remote inputs. They can be installed as shown on the wiring diagram.

For units in DICN configuration, note the following:

- Switch for remote on/off:
Units with status **NORMAL** or **STANDBY** will be controlled by the remote on/off switch connected to the chiller defined as **MASTER**.
Units with status **DISCONNECT ON/OFF** are controlled by the switch connected to them.
See also operation manual: "Selecting local or remote on/off control".
- Remote dual setpoint switch:
The remote dual setpoint switch may only be connected to the chiller defined as **MASTER**.
However in case the master drops out because of e.g. a power supply failure, it might be interesting to have the dual temperature switch installed to the other units as well.

Connecting field wiring

The routing of the field wiring must be as indicated in the figures below.

In the cover plate some free space is provided to install the appropriate nipples (drilling through the cover plate is required),

- for single circuit units: located below the field wiring terminals,
- for double circuit units: located below the mains switch.

Strap the wiring with a clamp (field supply) to the attachment plugs (1) as shown in the figures below to ensure strain relief of the wiring.

NOTE



In case mechanical stress occurs on the wiring, the earthing connections may not become loose before current-carrying connections do. Therefore make the earthing conductors longer than the current-carrying conductors.



Connection of field wiring to terminals

Pay special attention to markings on the terminals. The illustration below indicates corresponding positions to feed field wiring through correctly.

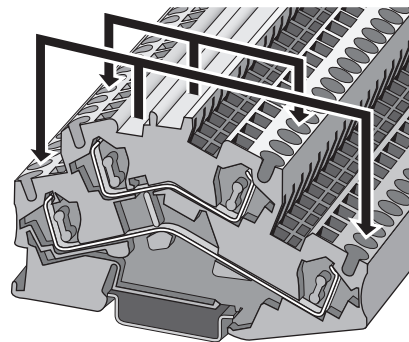

- **Power supply of factory mounted heater tape (option OP10) and additional heater tapes.**

An independent power supply 1~50 Hz, 230 V must be connected to the terminals as indicated on the wiring diagram supplied with the unit. The heater tapes must be connected to the independent power supply year-round. Separate fuses and a heater tape isolator switch must be installed in the field. Connect the earth conductor (yellow/green) to the earthing terminal ⊕. (Refer to the wiring diagram supplied with the unit.)

Use a power supply cable containing 2 conductors and ground with a cable section in function of:

- maximum current of 10 A,
- maximum ambient temperature of 60°C inside the switchbox.

Single circuit unit

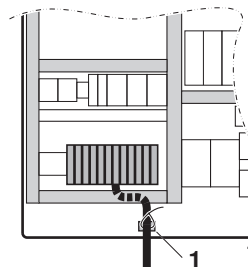

Double circuit unit

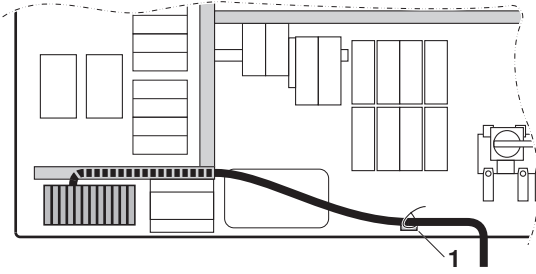

■ Connecting the pump (3~50 Hz, 400 V) in case of OPSC or OPTC

- For OPSC: pump contactor K1P is present
- For OPTC: pump contactors K1P and K2P are present

For each pump connection, use a cable containing 3 conductors + ground with a minimum conductor section of 2.5 mm².



The length of the earthing cable may not exceed 10 m. If the distance between pump and switch box is more than 10 m, the pump must be earthed independent of the switch box.

Maximum running current/pump as in the table below.

Units	Maximum running current/pump
EWYQ080+100	4.45 A
EWYQ130+150	6.30 A
EWYQ180~250	8.00 A

Connect L1, L2, and L3 to K1P (and to K2P in case of OPTC) and the earthing wire to the earth terminal on the left side of K1P as shown in the figures below.

Single circuit unit

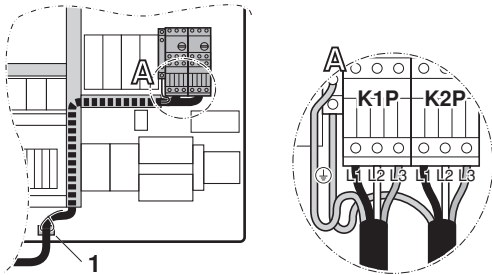

Double circuit unit

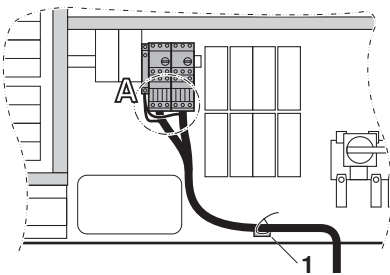

Connection and setup of a DICN system (option kit EKACPG)

(See Annex I, "Installation examples for a DICN configuration" on page 12)

For a system with chillers in a DICN configuration, the chillers have to be connected as shown in the figure below.

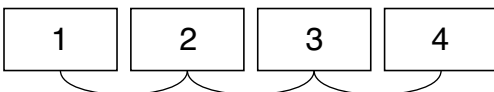

Make the F1/F2 connection for DIII communication as shown on the wiring diagram using a 2-core wire (0.75~1.25 mm²) (maximum of 1000 m).

Pay attention to the polarity!

DICN setup settings on the digital controller

When a DICN system is installed, adjust the settings on the digital controller as shown in the tables below:

Service menu, submenu, communication COMMUNICATION PCB (fifth screen)

	Unit 1 Master	Unit 2 Slave 1	Unit 3 Slave 2	Unit 4 Slave 3
DIII :	YES	YES	YES	YES
ADDR :	1-00	1-01	1-02	1-03
POWER :	Y	N	N	N

Service menu, submenu, DICN DICN SETTINGS (first screen)

	Unit 1 Master	Unit 2 Slave 1	Unit 3 Slave 2	Unit 4 Slave 3
MS OPTION :	Y (*)	Y	Y	Y
UNIT :	MASTER	SLAVE	SLAVE	SLAVE
NR OF SLAVES :	3	-	-	-

(*) The master unit must be set as last in row, otherwise set to N and back to Y.

DICN SETTINGS (second screen)

	Unit 1 Master	Unit 2 Slave 1	Unit 3 Slave 2	Unit 4 Slave 3
ADD SL1 :	1-01	-	-	-
ADD SL1 :	1-02	-	-	-
ADD SL1 :	1-03	-	-	-

NOTE



- When the user enters the service menu, the DIII communication stops.
- When the user leaves the service menu, the DIII communication restarts.
- It takes 10 minutes before DIII communication is fully re-established.
If communication fails after 10 minutes, the network safety error message "OU4:PCB COMM. PROBLEM" appears (also refer to symptom 12 in the chapter "Troubleshooting" in the operation manual).

Cable for remote digital controller (option kit EKRUPG)

In case you prefer to operate the unit from a distance, a remote digital controller can be connected to the PCB inside the unit. Specifications of the cable: 0.75 mm² 4 wire, and maximum 500 m long.

Setting the addresses on the remote digital controller

When a remote digital controller is used, the address has to be set by means of DIP-switches according to the drawing below:

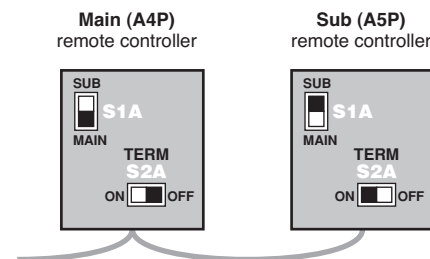

■ = DIP-switch position

Also refer to the wiring diagram delivered with the unit.

BEFORE STARTING



The unit may not be started, not even for a very short period of time, before the following pre-commissioning checklist is filled out completely.

tick ✓ when checked	standard steps to go through before starting the unit
<input type="checkbox"/>	1 Check for external damage .
<input type="checkbox"/>	2 Open all shut-off valves indicated by a red label: "OPEN THIS VALVE BEFORE OPERATION". (Open the liquid line, discharge and suction stop valves (if provided (OP12)) completely.)
<input type="checkbox"/>	3 Install main fuses, earth leak detector . Recommended fuses: gL/gG according to IEC standard 269-2. <i>Refer to the wiring diagram for size.</i>
<input type="checkbox"/>	4 Supply the main voltage and check if it is within the allowable $\pm 10\%$ limits of the nameplate rating. The electrical main power supply must be arranged so, that it can be switched on or off independently of the electrical supply to other items of the plant and equipment in general. <i>Refer to the wiring diagram, terminals L1, L2, L3 and PE.</i>
<input type="checkbox"/>	5 Check if all field wiring is correctly installed.
<input type="checkbox"/>	6 Supply water to the evaporator and verify if water flow is within the limits as given in the table under " Water charge, flow and quality " on page 4.
<input type="checkbox"/>	7 The piping must be completely purged .
<input type="checkbox"/>	8 Connect the pump contact , so that the unit can only come in operation when the water pumps are running and the water flow is sufficient. For DICN configurations, every chiller shall have its own flow switch and shall be interlocked with the pump from which it gets the flow.
<input type="checkbox"/>	9 Check the oil level in the compressors.
<input type="checkbox"/>	10 Connect the power supply to the heater tape terminals (factory mounted OP10) . The heater tape must be connected to an independent, separately fused, power supply all year-round.
<input type="checkbox"/>	11 Check that all the water sensors are correctly fixed into the connection pipes of the heat exchanger.
<input type="checkbox"/>	12 Check if after the power supply has been switched on, all changeable inputs and outputs are correctly configured. Note the correct configuration for each of the following changeable inputs and outputs: <ul style="list-style-type: none"> • DI 1 • DI 2 • DI 3 • DI 4 • DO 1 • DO 2 • DO 3 • DO 4 • DO 5 • DO 6 • AI 1 • AI 2 • AI 3 • AI 4 • AO 1

NOTE



- It is necessary to read the operation manual delivered with the unit before operating the unit. It will contribute to understand the operation of the unit and its electronic controller.
- Close all switchbox doors after installation of the unit.

I do confirm having executed and checked all the above mentioned items.

Date

Sign

Keep for future reference.

CUSTOMIZATION IN THE SERVICE MENU



All customized settings must be done by a licensed technician.

To change a setting in the service menu:

- 1 Enter the usersettings menu (⊞) as indicated in the operation manual and press the (▼) key to select the service menu, then press the (⊞) key (this is only possible if the unit is off).
- 2 Enter the correct password using the (▲) and (▼) keys. The password can be found in the service manual.
- 3 Press (⊞) to confirm the password and enter the service menu.
- 4 Go to the screen which contains the parameter to be modified by using the (▲) and (▼) keys.
- 5 Position the cursor behind the parameter to be modified using the (⊞) key.
- 6 Select the appropriate setting using the (▲) and (▼) keys.
- 7 Press (⊞) to confirm the modification. When the modification has been confirmed, the cursor switches to the next parameter which can now be configured.
- 8 Place the cursor in the top left corner of the screen when you are finished changing the parameters on this screen.
- 9 Repeat from instruction 4 onwards to modify other parameters.

Settings for units with glycol application (OPZL)

It is possible to change the minimum outlet water temperature (**MIN. OUTL. WATER**) in the service menu, submenu safety. Before lowering the minimum outlet water temperature:

- Make sure that sufficient glycol is added to the water system according to the table.
- Make sure that the settings are according to the table.

LWE(*)	°C	-10~-5	-5~0	0~2	2~5	5~20
Ethylene glycol	%	40	30	20	10	0
Propylene glycol	%	40	35	25	15	0
MIN. OUTL. WATER Minimum outlet water		-10	-5	0	2	5
FREEZE UP DIS Freeze-up disable temperature setting		-11	-6	-1	1	4
RESET Freeze-up disable temperature reset		-10	-5	0	2	5
REFR TEMP SET Refrigerant gas temperature setting		-18.5	-13.5	-8.5	-6.5	-3.5
LP SETP. C: Low pressure setpoint in cooling mode		0.5	0.5	0.5	1.2	1.2
PUMP ON SETP Pump on temperature setting(**)		-21.5	-14.5	-7.5	-2.5	1.5

(*) LWE = Leaving water evaporator

(**) No heater tape is present

- Settings as above result in cooling inlet and cooling outlet lower limits as shown in the table below.

LWE(*)	°C	-10~-5	-5~0	0~2	2~5	5~20
Ethylene glycol	%	40	30	20	10	0
Propylene glycol	%	40	35	25	15	0
COOL. INLSP 1/2 Lower limit of cooling inlet		-7	-2	3	5	8
COOL. OUTSP 1/2 Lower limit of cooling outlet		-10	-5	0	2	5

(*) LWE = Leaving water evaporator



Improper setting can result in severe damage of the equipment.

Setting the password for safety reset

Enter the **SAFETY** submenu through the service menu.

To avoid resetting of safeties by unqualified persons, the user password is asked by default when resetting a safety.

This password however can be changed to **SERVICE PASSWORD** or to **NONE**.

NOTE



Since inadequate resetting of safeties can damage the machine, it is advised to keep the default protection level setting of the **SAFETY** menu and certainly not to change it to **NONE**.

Setting of compressor running hours

Enter the **COMPRESSOR** submenu through the service menu.

When the displayed running hours do not comply with the actual running hours of the compressor it is possible to change the running hours to comply.

Defining of the changeable digital/analogue inputs and outputs

Enter the **INPUT OUTPUT** submenu through the service menu.

Besides locked inputs and outputs there are a number of changeable inputs and outputs of which the function can be chosen from several possibilities.

Possible functions for changeable digital inputs are:

- **NONE**: no function is appointed to the changeable digital input.
- **STATUS**: no function is appointed to the changeable digital input, but the input status can be read in the "INPUT OUTPUT" menu.
- **DUAL SETPOINT**: to switch between setpoints.
- **REMOTE ON/OFF**: to remotely switch the unit on or off.
- **REMOTE COOL/HEAT**: to remotely put the unit in cooling mode or in heating mode.
- **CAP. LIM 25%/50%/75%/SET**: to limit the capacity of the unit to the entered values.
- **FREE COOLING REQ**: to remotely put the unit into free cooling state.
- **FAN FORCED ON**: to activate the fans if the unit is off

Possible functions for the changeable digital output are:

- **NONE (OPEN)**: no function is appointed to the changeable digital output.
- **CLOSED**: no function is appointed to the changeable digital output, but the output is closed.
- **2ND PUMP**: can be used to steer a second evaporator pump.
- **100% CAPACITY**: indicates when the unit is working at 100%.
- **FULL CAPACITY**: indicates when the unit is working at maximum capacity, example reached 100% capacity or reached maximum capacity because of safety limitation.
- **FREE COOLING**: to control a 3-way water valve when the unit is working in free cooling state.
- **GEN. OPERATION**: indicates when the unit is switched on.
- **SAFETY+W. (NO)**: indicates that a safety or warning is active using a normal open contact.
- **SAFETY+W. (NC)**: indicates that a safety or warning is active using a normal closed contact.
- **SAFETY (NO)**: indicates that a safety is active using a normal open contact.
- **SAFETY (NC)**: indicates that a safety is active using a normal closed contact.

NOTE



- **NO**: normal open contact
Possible all changeable digital outputs
 - Safety active = contact closed
 - No power = contact open
 - No safety active = contact open
- **NC**: normal closed contact
Only possible on changeable digital output 1
 - Safety active = contact closed
 - No power = contact closed
 - No safety active = contact open

- **C1/C2 SAFETY**: indicates that a circuit safety is active.
- **WARNING**: indicates that a warning is active.
- **C1/C2 OPERATION**: indicates that a compressor of that circuit is switched on.
- **0% CAPACITY**: indicates that no compressors are switched on.
- **COOLING**: indicates that the cooling mode is active.
- **HEATING**: indicates that the heating mode is active.
- **DEFROST**: indicates that the defrost mode is active.

Possible configurations for the changeable analogue input are:

For each configuration of **CHANG. AI** the type must also be selected:

- **0-20mA, 4-20mA**
- **0-1V, 0-5V, 0-10V**
- **NTC TYPE 1, NTC TYPE 2, NTC TYPE 3, NTC TYPE 4** (Refer to the service manual to know what the different types of NTC sensors stand for.)
- **DI** (Digital input)
(for how to connect, refer to the wiring diagram)
- **NONE**: no function is appointed to the changeable analogue input.
- **STATUS**: only displays the status by means of test
- **FLOATING SETP**: floating setpoint based on ambient or analogue input (only available for **mA, V** or **NTC** types)
- **TEMPERATURE**: only displays the (by example) condenser outlet temperature (only available for **NTC** types)
- **DI*****: refer to the possible functions for changeable digital inputs. (***) can be any of the following: **STATUS, DUAL SETPOINT, REMOTE ON/OFF, REM. COOL/HEAT, FREE COOLING REQ, LOW NOISE** or **FAN FORCED ON.** (only available for **DI** (digital input) types)

Setting of the probe offset

Enter the **INPUT OUTPUT** submenu through the service menu.

It is possible to enter a correction value for certain measured temperatures (inlet water evaporator temperature and mixed outlet water evaporator temperature). This in order to correct a possible measurement fault. The default value of the probe offset, is equal to 0.

Steering the pump manually

Enter the **PUMP** submenu through the service menu

There is the possibility to turn the pump on or off manually. This means that when the unit is off the pump can also be turned on at any time to check the pump.

In case a heater tape is installed

Enter the **PUMP** submenu through the service menu

PUMPCONTROL
IF UNIT OFF AND LOW
WATER TEMP THEN PUMP
: OFF

The default setting is **OFF**. Modify this setting to **ON** in case the pump function is required.

In case no heater tape is installed, a pump can be activated in low ambient conditions when the unit is switched off.

Enter the **COMMUNICATION** submenu through the service menu.

The BMS parameters allowing communication between the unit and the supervisory system can be modified with the second **COMMUNICATION PCB** and the last **COMMUNICATION** screen of the service menu. The BMS parameters are:

COMMUNICATION PCB screen:

- **RS485**: indicates the serial connection **MODBUS** or **NONE**.
- **ADDR**: used to address the PCB.
- **BR**: indicates the speed of communication (Baud rate). The possible settings are: **1200**, **2400**, **4800**, **9600**, and **19200**.
- **PARITY**: indicates the parity, **NONE (2STOP_b)** with 2 stopbits, or **ODD/EVEN** with 1 stopbit (**1STOP_b**).

COMMUNICATION screen:

- **BMS CONTROL ALLOWED**: if set to **Y** (yes), the unit can be commanded and configured from a supervisory system. If set to **N** (no), the supervisory system can only read out values but cannot modify them.

Defining the thermostat settings

- For a stand-alone unit
Enter the first screen of the **THERMOSTAT** submenu through the service menu.
Defining the thermostat settings for inlet or outlet water temperature of **A** and **C** can only be set in the service menu.

```

THERMOSTAT
STEPLENGTH
A: 2.0°C    C: 0.4°C
RESTART COND.: Ax2
    
```

To define the thermostat settings of the inlet or outlet water temperature.

- For a unit connected in a DICN setup.
Enter, on the master unit only, the fourth screen of the **DICN** submenu through the service menu.
Defining the DICN thermostat settings for inlet water temperature of **A**, **B** and **C** can only be set in the service menu.

```

^ DICN THERMOSTAT
STEPLENGTH
A: 3.0°C B: 3.6°C C: 0.4°C
    
```

To define the thermostat settings of the inlet water temperature.

HOW TO CONTINUE

After installation and connection of the packaged air-cooled water chiller, the complete system must be checked and tested as described in "Checks before initial start-up" in the operation manual supplied with the unit.

Fill out the brief operation instructions form and fix it visibly near the operating site of the refrigeration system.

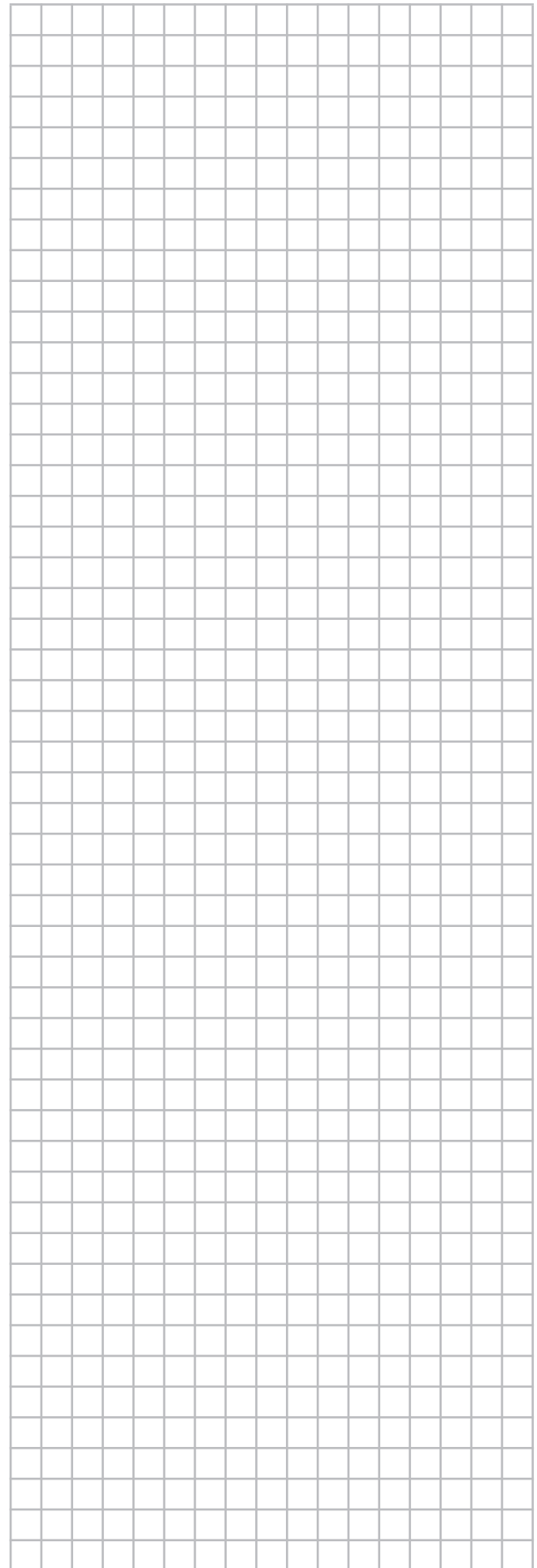

Installation examples for a DICN configuration

INTRODUCTION

This annex introduces 3 installation examples to help you set up your Daikin Integrated Chiller Network or DICN configuration.

Refer to "Connection and setup of a DICN system (option kit EKACPG)" on page 8.

EXAMPLES

Field wiring and wiring parts table



All field wiring and components must be installed by a licensed electrician and must comply with relevant European and national regulations.

The field wiring must be carried out in accordance with the wiring diagram supplied with the unit and instructions given below.

Be sure to use a dedicated power circuit. Never use a power supply shared by another appliance.

All customized settings must be done by a licensed technician.

For units with integrated pump, the pump contactor and pump interlock are already foreseen in the unit.

.....	Field wiring
-----	Earth wiring
●	Terminal on the unit
F1~F20.....	Fuses
K1P~K4P	Pump contact
L1,L2,L3,N.....	Main supply terminals
M1P~M5P	Pump motor
R9T	Sensor for secondary circuit
S3S	Manual switch for pump of master unit
S1S (M,S3).....	Remote start/stop switch
S2S	Dual setpoint selection switch
Y1S	3-way valve

Example 1: Single ring system with 1 pump

Figure 1 shows the system configuration, field wiring and terminals for field wiring of this example.

Purpose

Purpose of this system is to deliver a constant water flow at a constant temperature to a particular load. One unit, slave 3 (S3), is kept as a standby unit.

Setup

- The system is controlled on entering water temperature.
- The pump keeps running as long as 1 of the units is ON. After switching OFF all units, the pump runs for a time indicated by the **PUMPLAG** setting.
- Slave 3 (S3) is configured to operate when its remote start/stop switch S1S (S3) is pushed by the operator.
- Slave 1 (S1), slave 2 (S2) and the master unit (M) are switched ON or OFF using the remote start/stop switch S1S (M) which is connected to the master unit.
- The setpoint can be switched from **INLETSETP1** to **INLETSETP2** using the dual setpoint selection switch S2S which is connected to the master unit.

NOTE K*P can also be a 24 V DC or 230 V AC contactor.



Parameter settings of the units

Usersettings menu, submenu **DICN**:

	Slave 3	Slave 2	Slave 1	Master
MODE :	DISCONNECT ON/OFF	NORMAL	NORMAL	NORMAL
PUMP ON IF :	UNIT ON	UNIT ON	UNIT ON	UNIT ON

Changeable inputs/outputs must be defined as follows:

Service setting menu, submenu **INPUT OUTPUT**:

	Slave 3	Slave 2	Slave 1	Master
Terminal 46-47 S2S DI1	NONE	NONE	NONE	DUAL SETPOINT
Terminal 48-49 S1S DI2	REMOTE ON/OFF	NONE	NONE	REMOTE ON/OFF
Terminal 50-51 DI3	NONE	NONE	NONE	NONE
Terminal 52-53 DI4	NONE	NONE	NONE	NONE

Remark

Slave 3 can be configured to start up automatically if:

- 1 of the other units is in alarm or;
- all other units are running on full capacity and the setpoint is not reached yet.

To have your slave 3 unit act this way, set its mode to **STANDBY**. In this case, S1S (S3) has no function.

Example 2: Single ring system with separate pumps

Figure 2 shows the system configuration, field wiring and terminals for field wiring of this example.

Purpose

Purpose of this system is to deliver a constant water flow at a constant temperature to a particular load. One unit, slave 3 (S3), is kept as a standby unit.

Setup

- The system is controlled on entering water temperature.
- Pump 1, pump 2 and pump 3 keep running as long as the master unit, slave 1 or slave 2 are ON. Pump 4 only starts running if slave 3 is switched ON. After switching OFF the units, the pumps run for a time indicated by the **PUMPLAG** setting.
- Slave 3 (S3) is configured to operate when its remote start/stop switch S1S (S3) is pushed by the operator.
- Slave 1 (S1), slave 2 (S2) and the master unit (M) are switched ON or OFF using the remote start/stop switch S1S (M) which is connected to the master unit.
- The setpoint can be switched from **INLETSETP1** to **INLETSETP2** using the dual setpoint selection switch S2S which is connected to the master unit.

NOTE K*P can also be a 24 V DC or 230 V AC contactor.



Parameter settings of the units

Usersettings menu, submenu **DICN**

	Slave 3	Slave 2	Slave 1	Master
MODE :	DISCONNECT ON/OFF	NORMAL	NORMAL	NORMAL
PUMP ON IF :	UNIT ON	UNIT ON	UNIT ON	UNIT ON

Changeable inputs/outputs must be defined as follows:

Service setting menu, submenu **INPUT OUTPUT**

	Slave 3	Slave 2	Slave 1	Master
Terminal 46-47 S2S DI1	NONE	NONE	NONE	DUAL SETPOINT
Terminal 48-49 S1S DI2	REMOTE ON/OFF	NONE	NONE	REMOTE ON/OFF
Terminal 50-51 DI3	NONE	NONE	NONE	NONE
Terminal 52-53 DI4	NONE	NONE	NONE	NONE

Remark

Slave 3 can be configured to start up automatically if:

- 1 of the other units is in alarm or;
- all other units are running on full capacity and the setpoint is not reached yet.

To have your slave 3 unit act this way, set its mode to **STANDBY**. In this case, S1S (S3) has no function.

Example 3: Double ring system with several pumps

Figure 3 shows the system configuration, field wiring and terminals for field wiring of this example.

Purpose

Purpose of this system is to keep a buffer at a constant temperature and to feed a load from this buffer. One unit, slave 3 (S3), is kept as a standby unit.

Setup

- The system is controlled on entering water temperature.
- The pumps of the slave units only run when their compressor is running (energy saving). After stopping the compressor, the pump runs for a time indicated by the **PUMPLAG** setting.
- The pump of the master unit must run continuously so as to sense the correct temperature.
- Slave 3 (S3) is configured to operate when its remote start/stop switch S1S (S3) is pushed by the operator.
- Slave 1 (S1), slave 2 (S2) and the master unit (M) are switched ON or OFF using the remote start/stop switch S1S (M) which is connected to the master unit.
- The setpoint can be switched from **INLETSETP1** to **INLETSETP2** using the dual setpoint selection switch S2S which is connected to the master unit.

NOTE K*P can also be a 24 V DC or 230 V AC contactor.



Parameter settings of the units

Usersettings menu, submenu **DICN**:

	Slave 3	Slave 2	Slave 1	Master
MODE :	DISCONNECT ON/OFF	NORMAL	NORMAL	NORMAL
PUMP ON IF :	COMPR ON	COMPR ON	COMPR ON	COMPR ON

Changeable inputs/outputs must be defined as follows:

Service setting menu, submenu **INPUT OUTPUT**

	Slave 3	Slave 2	Slave 1	Master
Terminal 46-47 S2S DI1	NONE	NONE	NONE	DUAL SETPOINT
Terminal 48-49 S1S DI2	REMOTE ON/OFF	NONE	NONE	REMOTE ON/OFF
Terminal 50-51 DI3	NONE	NONE	NONE	NONE
Terminal 52-53 DI4	NONE	NONE	NONE	NONE

Remark

Slave 3 can be configured to start up automatically if:

- 1 of the other units is in alarm or;
- all other units are running on full capacity and the setpoint is not reached yet.

To have your slave 3 unit act this way, set its mode to **STANDBY**. In this case, S1S (S3) has no function.

NOTES

A large grid of graph paper for taking notes, consisting of 30 columns and 40 rows of small squares.

BRIEF OPERATION INSTRUCTIONS

EWYQ-DAYN Packaged air-cooled water chillers

Equipment supplier:

Service department:

.....

.....

Phone:

Phone:

EQUIPMENT TECHNICAL DATA

Manufacturer	: DAIKIN EUROPE N.V.	Power supply (V/Ph/Hz/A)	:
Model	:	Maximum high pressure	:45 bar
Serial Number	:	Charging weight (kg) R410A	:
Year of construction	:		

START-UP AND SHUT DOWN

- ▶ Start-up by switching on the circuit breaker of the power circuit. The operation of the water chiller is then controlled by the Digital Display Controller.
- ▶ Shut-down by switching off the controller and the circuit breaker of the power circuit.

WARNINGS

Emergency shut down : Switch off the **circuit breaker** located on

.....

.....

Air inlet and outlet : Always keep the air inlet and outlet free to obtain the maximum cooling capacity and to prevent damage to the installation.

Refrigerant charge : Use refrigerant R410A only.

First aid : In case of injuries or accidents immediately inform:



- ▶ **Company management** : **Phone**.....
- ▶ **Emergency physician** : **Phone**.....
- ▶ **Fire service** : **Phone**.....





4PW35559-1 D 000000W

Copyright 2007 Daikin

DAIKIN EUROPE N.V.

Zandvoordestraat 300, B-8400 Oostende, Belgium

4PW35559-1D 03.2011