

**DAIKIN**



# INSTALLATION AND OPERATION MANUAL

**Option kit for combination of Daikin  
condensing units with field supplied air  
handling units**

EKEQMCBV3



CE - DECLARATION-OF-CONFORMITY  
 CE - KONFORMITÄTSPRÄKLÄRUNG  
 CE - DECLARATION-DE-CONFORMITE  
 CE - CONFORMITEITSVERKLARING

CE - DECLARACION-DE-CONFORMIDAD  
 CE - DICHIARAZIONE-DI-CONFORMITA  
 CE - ΔΗΛΩΣΗ ΣΥΜΜΟΡΦΩΣΗΣ

CE - DECLARACÃO-DE-CONFORMIDADE  
 CE - ЗАРЯВЛЕНИЕ-О-СООТВЕТСТВИИ  
 CE - ОПЕЛДЖЕЛСЕРКЛЕРИНГ  
 CE - FÖRSÄKRAN-OM-ÖVERENSSTÄMMELSE

CE - IZJAVA O-USKLABENOSTI  
 CE - ILMOUTUS-YHDENMUKAISUUDESTA  
 CE - DEKLARACJA-ZGODNOSCI  
 CE - DECLARAȚIE-DE-CONFORMITATE

CE - IZJAVA O SKLADNOSTI  
 CE - VASTAVUSDEKLARATSIIOON  
 CE - DEKLARACIJA-ZA-CЪBETBECTBE  
 CE - ATTIKITES-DEKLARACIJA  
 CE - ATBLISTIBAS-DEKLARACIJA  
 CE - VYHLASENIE-ZHODY  
 CE - UYUMLUJLUK-BILDIRISI

CE - IZJAVA O SKLADNOSTI  
 CE - VASTAVUSDEKLARATSIIOON  
 CE - DEKLARACIJA-ZA-CЪBETBECTBE  
 CE - ATTIKITES-DEKLARACIJA  
 CE - ATBLISTIBAS-DEKLARACIJA  
 CE - VYHLASENIE-ZHODY  
 CE - UYUMLUJLUK-BILDIRISI

**Daikin Europe N.V.**

- 01 (GB) déclare sous sa seule responsabilité que l'air conditionning equipment to which this declaration relates;
- 02 (E) erklärt auf seine alleinige Verantwortung dass die Ausüstung der Klimaanlage für die diese Erklärung bestimmt ist;
- 03 (F) déclare sous sa seule responsabilité que l'équipement d'air conditionné visé par la présente déclaration;
- 04 (NL) verklaart hierbij op eigen exclusieve verantwoordelijkheid dat de airconditioningapparatuur waaraan deze verklaring betrekking heeft;
- 05 (E) declara bajo su única responsabilidad que el equipo de aire acondicionado al que hace referencia la declaración;
- 06 (I) dichiara sotto la propria responsabilità che gli apparecchi di condizionamento a cui le riferita questa dichiarazione;
- 07 (GR) δηλώνει με αποκλειστική της ευθύνη ότι ο εξοπλισμός των κλιματιστικών συσκευών στο οποίο αναφέρεται, η παρούσα δήλωση;
- 08 (P) declara sob sua exclusiva responsabilidade que os equipamentos de ar condicionado a que esta declaração se refere;

**EKEQIMCBV3\***

\* = . 1 . 2 . 3 . ... 9 \*

- 01 are in conformity with the following standard(s) or other normative document(s), provided that these are used in accordance with our instructions;
- 02 der/den folgenden Norm(en) oder einem anderen Normdokument oder Dokumenten entsprechend entsprechen, unter der Voraussetzung, dass sie gemäß unserer Anweisungen eingesetzt werden;
- 03 sono conformi a (alle) norme(s) o (altri) documenti(s) normativi, a patto che vengano usati in conformità alle nostre istruzioni;
- 04 gemäß den Vorschriften der:
- 05 conformen met aux stipulations des:
- 06 overeenkomstig de bepalingen van:
- 07 seguindo as disposições de:
- 08 secondo le prescrizioni per:
- 09 με τηρώντας τις διατάξεις των:
- 10 de acordo com o previsto em:
- 11 в соответствии с положениями:
- 12 under captioned conditions;
- 13 enligt villkoren i:
- 14 conformément aux stipulations des:
- 15 overeenkomstig de bepalingen van:
- 16 seguindo as disposições de:
- 17 secondo le prescrizioni per:
- 18 με τηρώντας τις διατάξεις των:
- 19 de acordo com o previsto em:
- 20 в соответствии с положениями:
- 21 under captioned conditions;
- 22 enligt villkoren i:
- 23 conformément aux stipulations des:
- 24 overeenkomstig de bepalingen van:
- 25 seguindo as disposições de:
- 26 secondo le prescrizioni per:
- 27 με τηρώντας τις διατάξεις των:
- 28 de acordo com o previsto em:
- 29 в соответствии с положениями:

**EN60335-2-40,**

- 19 obo upo številih določ:
- 20 vestaviti navedene:
- 21 smezavati krajvarje na:
- 22 laikantisi navedeti, paikittäm:
- 23 envergiot prasibas, kas noteiktas:
- 24 ordirarajuc uslanovien:
- 25 bunun kosulajama uygun olarak:

- 01 Note \* as set out in <B> and judged positively by <B> according to the Certificate <C>.
- 02 Hinweis \* wie in der <B> aufgeführt und von <B> positiv beurteilt gemäß Zertifikat <C>.
- 03 Remarque \* tel que défini dans <B> et évalué positivement par <B> conformément au Certificat <C>.
- 04 Bemerk \* zoals vermeld in <B> en positief beoordeeld door <B> overeenkomstig Certificaat <C>.
- 05 Nota \* como se establece en <B> y es valorado positivamente por <B> de acuerdo con el Certificado <C>.
- 06 Nota \* delineato nei <B> e giudicato positivamente da <B> secondo il Certificato <C>.
- 07 Znakovon \* όπως καθορίστηκε στο <B> και κρίστηκε θετικά από το <B> σύμφωνα με το Πιστοποιητικό <C>.
- 08 Nota \* tal como establecido en <B> e con o parecer positivo de <B> de acordo com o Certificado <C>.
- 09 Примечание \* как указано в <B> и в соответствии с положением сертификата <C>.
- 10 Bemerk \* som anförts i <B> og positivt vurderet af <B> henholdsvis til Certificat <C>.

- 09 (GB) заявляет, исключившись над своей ответственность, что оборудование для кондиционирования воздуха, к которому относится настоящее заявление;
- 10 (E) erklærer under entenskab, at udstyret til klimaregulering, som denne deklaration vedrører;
- 11 (S) deklarerer ägenskap av luftkonditioneringsutrustningen som berøres av denne deklarasjon innbittet att:
- 12 (N) erklærer et fulstændigt ansvar for at det luftkonditioneringsudstyr som berøres av denne deklarasjon, imødebarer at:
- 13 (NL) imachtia yksiman onalla vastuullisuus, että laäman ilmoituskesen tarkoituksellisesti toteutettuihin laitteisiin;
- 14 (CZ) prohlašuje ve své plné odpovědnosti, že klimatizační zařízení, k nimž se toto prohlášení vztahuje;
- 15 (GR) δηλώνει υπό αποκλειστική της ευθύνη ότι ο εξοπλισμός των κλιματιστικών συσκευών, η παρούσα δήλωση;
- 16 (P) declara sob sua exclusiva responsabilidade que o equipamento de ar condicionado a que esta declaração se refere;

- 17 (PL) deklaruje na własną odpowiedzialność, że klimatyzatory, których dotyczy niniejsza deklaracja;
- 18 (E) deklari på proprio răspundere că echipamentele de aer condiționat de aer condiționat la care se referă această declarație;
- 19 (S) z viso odgovornosti izjavljam, da je oprema klimatiskih naprav, na katero se izjave nanaša;
- 20 (ET) kinnitan oma läheiku vastuuskul, et käesoleva deklaratsiooni alla kuuluv klimaseadmete varustus;
- 21 (CZ) deklaruju na svoje odgovornost, ce oborudavato za klimatizacni instalacni, za vester ce onyava nazv deklarasur;
- 22 (LT) viskasa savo atsakomybės švelnia, kad oro kondicionavimo įranga, kuriai laikoma ši deklaracija;
- 23 (LV) ar pilnu atbildību apliecinu, ka šādi uzskaitītais gaisa kondicionēšanas iekārtas, uz kurām attiecas šī deklarācija;
- 24 (SK) vyhlasuje na vlastnu zodpovednost, ze klimatizacne zarizenie, na ktoré sa vzťahuje toto vyhlasenie;
- 25 (TR) lanamen kendi sorumluluğunda olmaks üzere bu bildirimli ilgili olduğu iklim donanımını aşağıdaki gibi olduğunu beyan eder;

- 16 megfelelnek az alábbi szabvány(ok)nak vagy egyéb irányadó dokumentum(ok)nak, ha azokat előírás szerint használják;
- 17 megfelel a normatív dokumentum(ok)nak, ha azokat előírás szerint használják;
- 18 sunt în conformitate cu următorii (următoare) standarde (sau alte) documente (normative), cu condiția ca acestea să fie utilizate în conformitate cu instrucțiunile noastre;
- 19 sind konform mit den nachfolgenden (nachfolgenden) Normen (oder anderen Normen), vorausgesetzt, dass diese Normen (oder anderen Normen) in Übereinstimmung mit den Anweisungen verwendet werden;
- 20 ovat vastavassa järjestyksessä standardien (tai muiden normatiivisten dokumenttien) mukaisia, jos niitä käytetään ohjeidenmukaan;
- 21 съответстват на следните стандарти или други нормативни документи, при условие, че се използват съгласно нашите инструкции;
- 22 atitinka žemiau nurodytus standartus ir (arba) kitus norminius dokumentus su sąlyga, kad yra naudojami pagal mūsų nurodymus;
- 23 tad, ja tie ir atbilstošā secībā norādītiem, atbilst šajiem standartiem un citiem normatīviem dokumentiem;
- 24 sú v zhodě s následujícími (následujícími) normami (nebo jinými) normativními dokumenty (normami);
- 25 inünün, talimatlarına göre kullanımını kosululuja aşağıdaki standartlar ve norm belirlen belgelerle uyumludur;

- 01 Direktives, as amended;
- 10 Direktiv, med senere ændringer;
- 11 Direktiv, med foretagne ændringer;
- 12 Direktives, telles que modifiées;
- 13 Richtlijnen, zoals gearmderd;
- 14 v pätien změní;
- 15 Smernice, kako je izmjenjeno;
- 16 irányelvek és módosítások rendelkezései;
- 17 z późniejszych poprawkami;
- 18 Directivelor, cu amendamentele respective;

- 21 Забелешка \* картата е изготвена в <B> и оценена положително от <B> съгласно Сертификата <C>.
- 22 Pastaba \* kaip nustatyta <B> ir kaip teigiamai nuslyta <B> pagal Serifikatą <C>.
- 23 Poznamka \* ka navedis <B> un atbilstoš <B> pozitīvajam vērtējumam saskaņā ar sertifikātu <C>.
- 24 Poznámka \* ako bolo uvedené v <B> a pozitívne zistené <B> v súlade s osvedčením <C>.
- 25 Not \* <A> da bejrtitelti gbi, ve <C> Serifikasima gőre <B> taradından olumlu olarak değerdendirildi gbi.

**Low Voltage 2006/95/EC \*  
 Electromagnetic Compatibility 2004/108/EC \***

- 16 Megjegyzés \* a(z) <A> alapján, a(z) <B> igazolta a megfelelést, a(z) <C> tanúsítvány szerint.
- 17 Uwaga \* zgodnie z dokumentacją <B> pozytywną opinią jedkoma em <B> i zgodnie z <B> Swiadectwem <C>.
- 18 Noia \* asa cum este stabilit in <A> si anexat pozitiv hysăsiy/Serifikacii <C> măsăsi.
- 19 Opomba \* kaj je doobeno v <B> in odobeno s strani <B> v skladu s osvedčenjem <C>.
- 20 Märkus \* kako je izloženo u <A> pozitivno odobjeno od naručitelja dokumenta <A> ja heels kateud <B> jati vstavari sertifikacii <C>.

- 11 Information \* enigi <A> och godkänns av <B> enligt Certifikat <C>.
- 12 Merk \* som del fremkommer i <A> og gjennom positiv bedømmelse av <B> i henhold til <B> Svidactwen <C>.
- 13 Huom \* jalka em este stabilit in <A> si anexat pozitiv hysăsiy/Serifikacii <C> măsăsi.
- 14 Pozornia \* jak bylo odobeno v <B> a pozitivně zjšeno <B> v souladu s osvedčením <C>.
- 15 Napomena \* kako je izloženo u <A> pozitivno odobjeno od naručitelja dokumenta <A> ja heels kateud <B> jati vstavari sertifikacii <C>.



**CONTENTS**

Page

**Introduction** ..... 1

Before installation ..... 1

**Installation** ..... 2

Accessories ..... 2

Name and function of parts ..... 2

Before installation ..... 2

Selecting the installation site ..... 3

Piping installation ..... 3

Valve kit installation ..... 5

Installation of the electrical control box ..... 6

Electric wiring work ..... 6

Installation of thermistors ..... 8

Refrigerant piping work ..... 9

Test operation ..... 9

**Operation and maintenance** ..... 9

What to do before operation ..... 9

Operation and display signals ..... 9

Troubleshooting ..... 10

Maintenance ..... 10

Disposal requirements ..... 10

**INTRODUCTION**



- Do only use this system in combination with a field supplied air handling unit. Do not connect this system to other appliances.
- Only optional controls as listed in the optional accessories list can be used.

**BEFORE INSTALLATION**

The system will operate as a standard indoor unit to control the room temperature. This system does not require a specific external controller but take below cautions into account.

- Multiple outdoor unit connections are not allowed in 1 refrigerant system.
- The automatic refrigerant charging and leak detection function are not possible when the EKEQMCB is used.
- The manufacturer of this outdoor unit has limited responsibility for total performance of the system because performance is determined by the total system. The discharge air may fluctuate depending on selected air handling unit and depending on the installation configuration.
- Do NOT connect the system to DIII-net devices:

- **Intelligent<sup>touch</sup> Controller**
- **Intelligent Manager**
- **DMS-IF**
- **BACnet Gateway**
- ...

This could result in malfunction or breakdown of the total system.

- This equipment is not designed for year-round cooling applications with low indoor humidity conditions, such as Electronic Data Processing rooms.
- This appliance is not intended for use by persons, including children, with reduced physical, sensory or mental capabilities, or lack of experience and knowledge, unless they have been given supervision or instruction concerning use of the appliance by a person responsible for their safety. Children should be supervised to ensure that they do not play with the appliance.



READ THESE INSTRUCTIONS CAREFULLY BEFORE INSTALLATION AND OPERATION.

IMPROPER INSTALLATION OR ATTACHMENT OF EQUIPMENT OR ACCESSORIES COULD RESULT IN ELECTRIC SHOCK, SHORT-CIRCUIT, LEAKS, FIRE OR OTHER DAMAGE TO THE EQUIPMENT. BE SURE ONLY TO USE ACCESSORIES MADE BY DAIKIN WHICH ARE SPECIFICALLY DESIGNED FOR USE WITH THE EQUIPMENT AND HAVE THEM INSTALLED BY A PROFESSIONAL.









IF UNSURE OF INSTALLATION PROCEDURES OR USE, ALWAYS CONTACT YOUR DAIKIN DEALER FOR ADVICE AND INFORMATION.

The English text is the original instruction. Other languages are translations of the original instructions.

## INSTALLATION

- For installation of the air handling unit, refer to the air handling unit installation manual.
- Never operate the air conditioner with the discharge pipe thermistor (R3T), suction pipe thermistor (R2T) and pressure sensors (S1NPH, S1NPL) removed. Such operation may burn out the compressor.
- The equipment is not intended for use in a potentially explosive atmosphere.

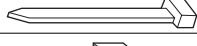
## ACCESSORIES

		Quantity
Thermistor (R1T)		1
Thermistor (R3T/R2T) (2.5 m cable)		2
Insulation sheet		2
Rubber sheet		2
Wire to wire splice		6
Installation and operation manual		1
Screw nut		9
Tie wrap		6
Capacity setting adaptor		8
Stopper (closing cup)		1

### Obligatory accessory

EKEQMCB	
Expansion valve kit	EKEXV

Refer to chapter "Valve kit installation" on page 5 for installation instructions.

### Optional accessories

EKEQMCB	
Remote controller	 1

## NAME AND FUNCTION OF PARTS (See figure 1)

### Parts and components

- Outdoor unit
- Control box
- Air handling unit (field supply)
- Field piping (field supply)
- Expansion valve kit

### Wiring connections

- Outdoor unit power supply
- Control box wiring  
(Power supply and communication between control box and outdoor unit)
- Air handling unit thermistors
- Power supply and control wiring for air handling unit and controller  
(power supply is separate from the outdoor unit)
- Air thermistor control for air handling unit
- Remote controller

## BEFORE INSTALLATION

- Refer to the installation manual of the outdoor unit for details on refrigerant piping, additional refrigerant charging, and inter-unit wiring.



Since design pressure is 4 MPa or 40 bar, pipes of larger wall thickness may be required. Refer to paragraph "Selection of piping material" on page 4.

- Precautions for R410A
  - The refrigerant requires strict cautions for keeping the system clean, dry and tight.
    - Clean and dry
      - Foreign materials (including mineral oils or moisture) should be prevented from getting mixed into the system.
    - Tight
      - Read "Piping installation" on page 3 carefully and follow these procedures correctly.
  - Since R410A is a mixed refrigerant, the required additional refrigerant must be charged in its liquid state. (If the refrigerant is in state of gas, its composition changes and the system will not work properly).
  - The connected air handling units must have heat exchangers designed exclusively for R410A.

### Cautions for selection of the air handling unit

Select the air handling unit (field supply) according to the technical data and limitations mentioned in Table 1.

Lifetime of the outdoor unit, operation range or operation reliability may be influenced if you neglect these limitations.

This control box can only be used in heat pump applications.

### NOTE



- For maximum number of indoor units, see the outdoor unit specifications.
- If the total capacity of the connected indoor units exceeds the capacity of the outdoor unit, cooling and heating performance may drop when running the indoor units. Refer to the section on performance characteristics in the Engineering Data Book for details.
- The capacity class of the air handling unit is determined by the selection of the expansion valve kit according to Table 1.

Depending on the heat exchanger, a connectable EKEXV (expansion valve kit) must be selected to these limitations.

Table 1

EKEXV class	Allowed heat exchanger volume (dm <sup>3</sup> )		Allowed heat exchanger capacity (kW)	
	Minimum	Maximum	Minimum	Maximum
50	0.76	1.65	5.0	6.2
63	1.66	2.08	6.3	7.8
80	2.09	2.64	7.9	9.9
100	2.65	3.30	10.0	12.3
125	3.31	4.12	12.4	15.4
140	4.13	4.62	15.5	17.6
200	4.63	6.60	17.7	24.6
250	6.61	8.25	24.7	30.8

Saturated suction temperature (SST) = 6°C, SH (superheat) = 5 K, air temperature = 27°C DB / 19°C WB.

- The air handling unit can be connected as a standard indoor unit to the outdoor unit. The limitations of connection are determined by the outdoor unit.



Additional limits exist when connecting the EKEQMCB control box. These can be found in the technical data book of the EKEQMCB and in this manual.

## 2 Selecting the expansion valve

The corresponding expansion valve needs to be selected for your air handling unit. Select the expansion valve according to the above limitations.

### NOTE



- If conflicting result, capacity selection has priority over volume.
- The expansion valve is an electronic type, it is controlled by the thermistors that are added in the circuit. Each expansion valve can control a range of air handling units sizes.
- The selected air handling unit must be designed for R410A.
- Extraneous substances (including mineral oils or moisture) must be prevented from getting mixed into the system.
- SST: saturated suction temperature at exit of air handling unit.

## 3 Selecting the capacity setting adaptor (see accessories)

- The corresponding capacity setting adaptor needs to be selected depending on the expansion valve.
- Connect the correct selected capacity setting adaptor to X24A (A1P). (See figure 3)

EKEXV kit	Capacity setting adaptor label (indication)
50	J56
63	J71
80	J90
100	J112

EKEXV kit	Capacity setting adaptor label (indication)
125	J140
140	J160
200	J224
250	J280

For the following items, take special care during construction and check after installation is finished

Tick ✓ when checked	
<input type="checkbox"/>	Are the thermistors fixed firmly? Thermistor may come loose.
<input type="checkbox"/>	Is the freeze-up setting done correctly? The air handling unit may freeze up.
<input type="checkbox"/>	Is the control box fixed firmly? The unit may drop, vibrate or make noise.
<input type="checkbox"/>	Do electrical connections comply with specifications? The unit may malfunction or components may burn out.
<input type="checkbox"/>	Are wiring and piping correct? The unit may malfunction or components may burn out.
<input type="checkbox"/>	Is the unit safely grounded? Dangerous at electric leakage.

## SELECTING THE INSTALLATION SITE

This is a class A product. In a domestic environment this product may cause radio interference in which case the user may be required to take adequate measures.

Select an installation site where the following conditions are fulfilled and that meets your customer's approval.

- The option boxes (expansion valve and electrical control box) can be installed inside and outside.
- Do not install the option boxes in or on the outdoor unit.
- Do not put the option boxes in direct sunlight. Direct sunlight will increase the temperature inside the option boxes and may reduce its lifetime and influence its operation.
- Choose a flat and strong mounting surface.
- Operating temperature of the control box is between  $-10^{\circ}\text{C}$  and  $40^{\circ}\text{C}$ .
- Keep the space in front of the boxes free for future maintenance.
- Keep air handling unit, power supply wiring and transmission wiring at least 1 m away from televisions and radios. This is to prevent image interference and noise in those electrical appliances. (Noise may be generated depending on the conditions under which the electric wave is generated, even if 1 m is kept.)
- Make sure the control box is installed horizontally. Screw nuts position must be downwards.

## Precautions

Do not install or operate the unit in rooms mentioned below.

- Where mineral oil, like cutting oil is present.
- Where the air contains high levels of salt such as air near the ocean.
- Where sulphurous gas is present such as that in areas of hot spring.
- In vehicles or vessels.
- Where voltage fluctuates a lot such as that in factories.
- Where high concentration of vapor or spray are present.
- Where machines generating electromagnetic waves are present.
- Where acidic or alkaline vapor is present.
- The option boxes must be installed with entrances downward.

## PIPING INSTALLATION

### Piping limits

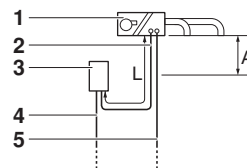

- Air handling unit
- Connection pipe from expansion valve kit to air handling unit
- Valve kit
- Liquid pipe
- Gas pipe

	Max (m)
A	$-5/+5^{(*)}$
L	5

(\*) Below or above the valve kit.

L is to be considered as a part of the total maximum piping length. See installation manual of the outdoor unit for piping installation.

## Piping connections

Make sure to install gas and liquid pipe diameters in function of the air handling unit capacity class.

Air handling unit capacity class	Gas pipe	Connection pipe Liquid pipe
50	Ø12.7	Ø6.4
63	Ø15.9	Ø9.52
80		
100		
125		
140		
200	Ø19.1	
250	Ø22.2	

## Selection of piping material

- Foreign materials inside pipes (including oils for fabrication) must be 30 mg/10 m or less.
- Use the following material specification for refrigerant piping:
  - Construction material: phosphoric acid deoxidized seamless copper for refrigerant.
  - Temper grade: use piping with temper grade in function of the pipe diameter as listed in the table below.

Pipe Ø	Temper grade of piping material
≤15.9	O
≥19.1	1/2H

O = Annealed  
1/2H = Half hard

- The pipe thickness of the refrigerant piping should comply with relevant local and national regulations. The minimal pipe thickness for R410A piping must be in accordance with the table below.

Pipe Ø	Minimal thickness t (mm)
6.4	0.80
9.5	0.80
12.7	0.80
15.9	0.99
19.1	0.80
22.2	0.80

- In case the required pipe sizes (inch sizes) are not available, it is also allowed to use other diameters (mm sizes), taken the following into account:
  - select the pipe size nearest to the required size.
  - use the suitable adapters for the change-over from inch to mm pipes (field supply).

## Cautions for brazing

- Be sure to carry out a nitrogen blow when brazing. Brazing without carrying out nitrogen replacement or releasing nitrogen into the piping will create large quantities of oxidized film on the inside of the pipes, adversely affecting valves and compressors in the refrigerating system and preventing normal operation.
- When brazing while inserting nitrogen into the piping, nitrogen must be set to 0.02 MPa with a pressure-reducing valve (=just enough so that it can be felt on the skin).

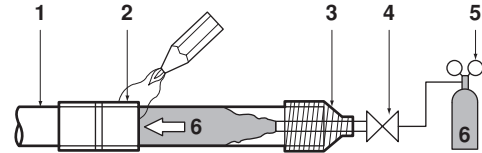

- Refrigerant piping
- Part to be brazed
- Taping
- Hands valve
- Pressure-reducing valve
- Nitrogen

- For details, see manual of the outdoor unit.



## VALVE KIT INSTALLATION

### Mechanical installation

- 1 Remove the valve kit box cover by unscrewing 4x M5.
- 2 Drill 4 holes on correct position (measurements as indicated in figure below) and fix the valve kit box securely with 4 screws through the provided holes Ø9 mm.



- NOTE**
- Make sure that the expansion valve is installed vertically.
  - Make sure there is enough free space for future maintenance.

### Brazing work

For details, see manual of the outdoor unit.

- 3 Prepare the inlet/outlet field piping just in front of the connection (do **not** braze yet).

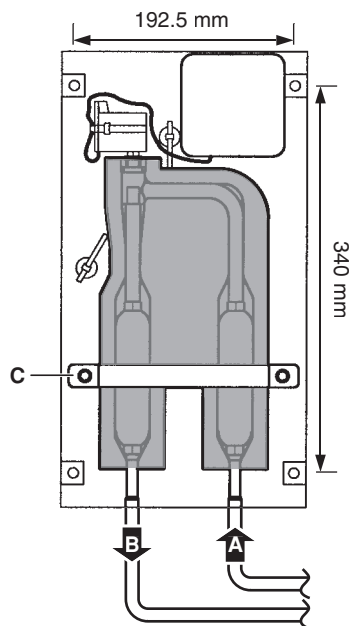

- A Inlet coming from the outdoor unit  
 B Outlet to air handling unit  
 C Pipe fixing clamp

- 4 Remove the pipe fixing clamp (C) by unscrewing 2x M5.
- 5 Remove the upper and lower pipe insulations.
- 6 Braze the field piping.



- Make sure to cool the filters and valve body with a wet cloth and make sure the body temperature does not exceed 120°C during brazing.
- Make sure that the other parts such as electrical box, tie wraps and wires are protected from direct brazing flames during brazing.

- 7 After brazing, put the lower pipe insulation back in place and close it with the upper insulation cover (after peeling off the liner).
- 8 Secure the pipe fixing clamp (C) in place again (2x M5).
- 9 Make sure that field pipes are fully insulated.  
 Field pipe insulation must reach up to the insulation you have put back in place as per procedure step 7. Make sure that there is no gap between both ends in order to avoid condensation dripping (finish the connection with tape eventually).

### Electrical work

- 1 Open the electrical box cover (A).
- 2 Push out **ONLY** the second lower wire intake hole (B) from inside to outside. Do not damage the membrane.
- 3 Pass valve cable (with wires Y1 ... Y6) from the control box through that membrane wire intake hole and connect the cable wires into the terminal connector (C) following instructions as described in step 4. Route the cable out of the valve kit box according to figure below and fix with the tie wrap (D). See "Electric wiring work" on page 6 for more details.

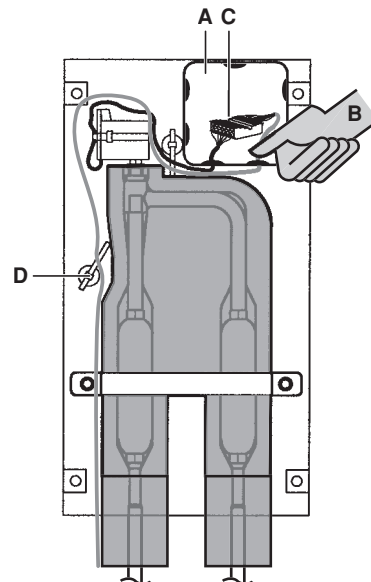

- 4 Use a small screwdriver and follow indicated instructions for connecting cable wires into the terminal connector according to the wiring diagram.

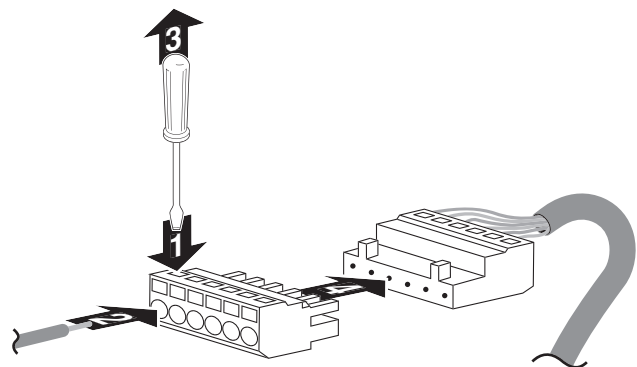

- 5 Make sure that field wiring and insulation is not squeezed when closing the valve kit box cover.
- 6 Close the valve kit box cover (4x M5).



## INSTALLATION OF THE ELECTRICAL CONTROL

### BOX (See figure 3)

- 1 Control box
- 2 Hanger brackets
- 3 Main PCB
- 4 Transformer
- 5 Terminal
- 6 Optional PCB (KRP4)

### Mechanical installation

- 1 Fix the control box with its hanger brackets to the mounting surface.  
Use 4 screws (for holes of Ø6 mm).
- 2 Open the lid of the control box.
- 3 For electrical wiring: refer to paragraph "Electric wiring work" on page 6.
- 4 Install the screw nuts.
- 5 Close the unnecessary openings with stoppers (closing cups).
- 6 Close the lid securely after installation to ensure that the control box is watertight.

## ELECTRIC WIRING WORK

- All field supplied parts and materials and electric works must be conform to local codes.
- Use copper wire only.
- All wiring must be performed by an authorized electrician.
- A main switch or other means for disconnection, having a contact separation in all poles, must be incorporated in the fixed wiring in accordance with relevant local and national legislation.
- Refer to the installation manual attached to the outdoor unit for the size of power supply electric wire connected to the outdoor unit, the capacity of the circuit breaker and switch, wiring and wiring instructions.
- Attach the earth leakage circuit breaker and fuse to the power supply line.

### Connection of the wires inside the control box

- 1 For connection to outdoor unit and to controller (field supply):  
Pull the wires inside through the screw nut and close the nut firmly in order to ensure a good pull relieve and water protection.
- 2 The cables require an additional pull-relief. Strap the cable with the installed tie wrap.-

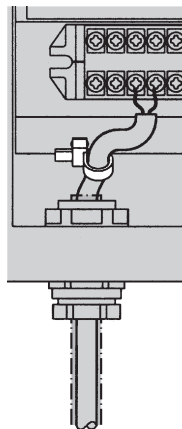

## Precautions

- Thermistor cable and remote controller wire should be located at least 50 mm away from power supply wires and from wires to the controller. Not following this guideline may result in malfunction due to electrical noise.
- Use only specified wires, and tightly connect wires to the terminals. Keep wiring in neat order so that it does not obstruct other equipment. Incomplete connections could result in overheating, and in worse case electric shock or fire.

## Connecting the wiring: EKEQMCBV3



- Connect the wires to the terminal board according to the wiring diagram in [figure 2](#). See [figure 3](#) for wiring intake in the control box. The wiring intake hole indication H1 refers to the H1 cable of the corresponding wiring diagram. There are 2 wiring intake holes to allow for branching of the communication wire.
- Connect cables according to specifications of the next table.

### Table connection and application

	Description	Connect to	Type of cable	Cross section (mm <sup>2</sup> ) <sup>(*)</sup>	Maximum length (m)	Specifications
L, N, earth	Power supply	Power supply	H05VV-F3G2.5	2.5	—	Power supply 230 V 1~ 50 Hz
Y1~Y6	Expansion valve connection	Expansion valve kit	LIYCY3 x 2 x 0.75	0.75	20	Digital output 12 V DC
R1,R2	Thermistor R2T (liquid pipe)	—	H05VV-F2 x 0.75		Standard: 2.5 Max.: 20	Analog input 16 V DC
R3,R4	Thermistor R3T (gas pipe)					
R5,R6	Thermistor R1T (air)					
P1,P2	Remote controller					
F1,F2	Communication to outdoor unit	Outdoor unit			100	Communication line 16 V DC
T1,T2	ON/OFF	Controller field supply	LIYCY4 x 2 x 0.75	Optional connection: when the function of the switch box needs to be extended: see KRP4A51 for details of settings and instructions.	—	Digital input 16 V DC
—	Capacity step					
—	Error signal					
—	Operation signal					
C1,C2	Fan signal	Air handling unit fan field supply	H05VV-F3G2.5	2.5	—	Digital output: voltage free. Maximum 230 V, maximum 2 A

(\*) Recommended size (all wiring must comply with local codes).

### Wiring diagram

A1P .....	Printed circuit board		Field wiring
A2P .....	Printed circuit board (option KRP4)	L .....	Live
F1U .....	Fuse (250 V, F5A)(A1P)	N .....	Neutral
F3U .....	Field fuse		Connector
HAP .....	Light emitting diode (service monitor-green)	○ .....	Wire clamp
K1R .....	Magnetic relay		Protective earth (screw)
K4R .....	Magnetic relay (fan)	— — — .....	Separate component
Q1DI .....	Earth leakage breaker	==:== .....	Optional accessory
R1T .....	Thermistor (air)	BLK .....	Black
R2T .....	Thermistor (liquid)	BLU .....	Blue
R3T .....	Thermistor (gas)	BRN .....	Brown
R7 .....	Capacity adaptor	GRN .....	Green
T1R .....	Transformer (220 V/21.8 V)	GRY .....	Gray
X1M,X3M .....	Terminal block	ORG .....	Orange
Y1E .....	Electronic expansion valve	PNK .....	Pink
X1M-C1/C2 .....	Output: fan ON/OFF	RED .....	Red
X1M-F1/F2 .....	Communication outdoor unit	WHT .....	White
X1M-P1/P2 .....	Communication remote controller	YLW .....	Yellow
X1M-R1/R2 .....	Thermistor liquid		
X1M-R3/R4 .....	Thermistor gas		
X1M-R5/R6 .....	Thermistor air		
X1M-T1/T2 .....	Input: ON/OFF		
X1M-Y1~6 .....	Expansion valve		

# INSTALLATION OF THERMISTORS

## Refrigerant thermistors

### Location of the thermistor

A correct installation of the thermistors is required to ensure a good operation:

1. Liquid (R2T)  
Install the thermistor behind the distributor on the coldest pass of the heat exchanger (contact your heat exchanger dealer).
2. Gas (R3T)  
Install the thermistor at the outlet of the heat exchanger as close as possible to the heat exchanger.

Evaluation must be done to check if the air handling unit is protected against freeze-up.

Execute test operation and check for freeze-up.

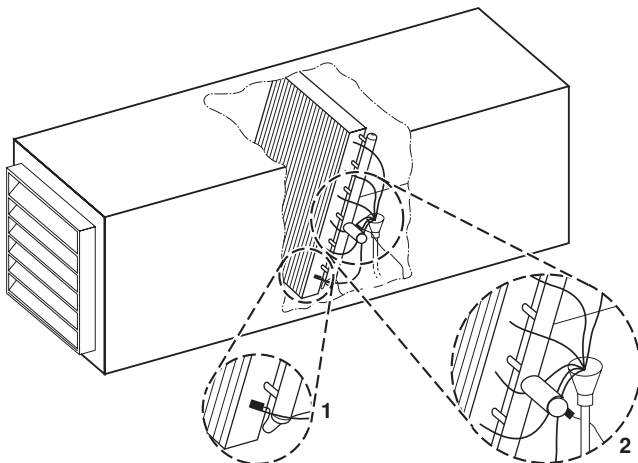

- 1 Liquid R2T
- 2 Gas R3T

### Installation of the thermistor cable

- 1 Put the thermistor cable in a separate protective tube.
- 2 Always add a pull-relief to the thermistor cable to avoid strain on the thermistor cable and loosening of the thermistor. Strain on the thermistor cable or loosening of the thermistor may result in bad contact and incorrect temperature measurement.

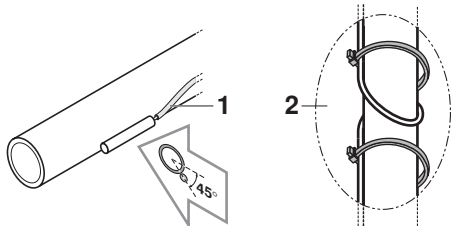

### Fixation of the thermistor



- Put the thermistor wire slightly down to avoid water accumulation on top of the thermistor.

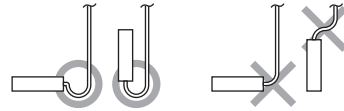

- Make good contact between thermistor and air handling unit. Put the top of the thermistors on the air handling unit, this is the most sensitive point of the thermistor.

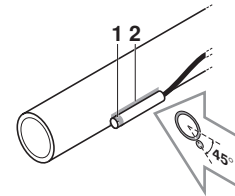

- 1 Most sensitive point of the thermistor
- 2 Maximize the contact

- 1 Fix the thermistor with insulating aluminum tape (field supply) in order to ensure a good heat transference.

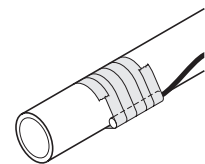

- 2 Put the supplied piece of rubber around the thermistor (R2T/R3T) in order to avoid loosening of the thermistor after some years.

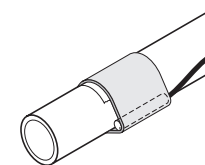

- 3 Fasten the thermistor with 2 tie wraps.

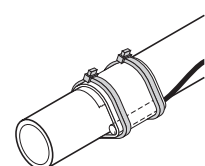

- 4 Insulate the thermistor with the supplied insulation sheet.

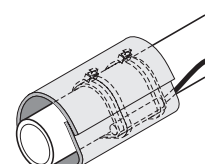

### Air thermistor

The air thermistor (R1T) can be installed either in the room that needs temperature control or in the suction area of the air handling unit.



**NOTE** For room temperature control the delivered thermistor (R1T) can be replaced by an optional remote sensor kit KRCS01-1(A) (to be ordered separately).

## Installation of longer thermistor cable (R1T/R2T/R3T)

The thermistor is supplied with a standard cable of 2.5 m. This cable can be made longer to up to 20 m.

### Install the longer thermistor cable with the delivered wire to wire splices

- 1 Cut the wire or bundle the remainder of the thermistor cable.  
Keep at least 1 m of the original thermistor cable.  
Do not bundle the cable inside the control box.
- 2 Strip the wire  $\pm 7$  mm at both ends and insert these ends into the wire to wire splice.
- 3 Pinch the splice with the correct crimp tool (pliers).
- 4 After connection, heat up the shrink-insulation of the wire to wire splice with a shrink-heater to make a water tight connection.
- 5 Wrap electrical insulation tape around the connection.
- 6 Put a pull-relief in front of and behind the connection.



- The connection must be made on an accessible location.
- To make the connection waterproof, the connection can also be made in a switch box or connector box.
- The thermistor cable should be located at least 50 mm away from power supply wire. Not following this guideline may result in malfunction due to electrical noise.

## REFRIGERANT PIPING WORK



All field piping must be provided by a licensed refrigeration technician and must comply with the relevant local and national codes.

- For refrigerant piping of outdoor unit, refer to the installation manual supplied with the outdoor unit.
- Follow the outdoor unit specifications for additional charging, piping diameter and installation.
- The maximum allowed piping length depends on the connected outdoor model.

## TEST OPERATION

Before executing "test operation" as well as before operating the unit, you must check the following:

- Refer to the section of "For the following items, take special care during construction and check after installation is finished" on page 3.
- After finishing the construction of refrigerant piping, drain piping and electric wiring, conduct test operation accordingly to protect the unit.
- Open the gas side stop valve.
- Open the liquid side stop valve.

### Executing the test operation

- 1 Close the contact T1/T2 (ON/OFF).
- 2 Confirm function of the unit according to the manual and check if the air handling unit has collected ice (freeze-up).  
If the unit collects ice: see "Troubleshooting" on page 10.
- 3 Confirm that the fan of the air handling unit is ON.



- In case of poor distribution in the air handling unit, 1 or more passes of the air handling unit may freeze-up (collect ice) → put the thermistor (R2T) on this position.
- Depending on operation conditions (e.g.: outdoor ambient temperature) it is possible that the settings must be changed after commissioning.

## OPERATION AND MAINTENANCE

If T1/T2 is applicable:

- Closing the T1/T2 signal starts operation of the air handling unit.
- Opening the T1/T2 signal stops operation of the air handling unit.

## WHAT TO DO BEFORE OPERATION



- Before initiating operation, contact your dealer to get the operation manual that corresponds to your system.
- Refer to the dedicated manual of the controller (field supply) and air handling unit (field supply).
- Make sure that the air handling unit fan is ON when the outdoor unit is in normal operation.

### Field settings for EKEQMCB

Refer to the installation manuals of both the outdoor unit and the remote controller.

### Operation setting in case of power failure



Measures must be taken to ensure that after power failure, T1/T2 is according to the setting of your preference. Neglecting this caution will result in improper operation.

Mode No.	Code No.	Description of setting
12(22)-5	01	T1/T2 must be open at power restore. <sup>(*)</sup>
	02	After power failure, the status of T1/T2 must remain identical to the initial T1/T2 status prior to the power failure.

<sup>(\*)</sup> After power failure, T1/T2 must be changed to open (no cooling/heating requested).

## OPERATION AND DISPLAY SIGNALS

Input	T1/T2 <sup>(*)</sup>	Open	No cooling/heating requested
		Closed	Cooling/heating requested

<sup>(\*)</sup> See field setting 12(22)-5.

### NOTE



- See the remote controller display for output.
- See optional kit KRP4A51 for additional possible signals.



When the operation signal is activated, the air handling unit and fan must operate. Failure to this will cause a safety to operate or freezing up of the air handling unit.

## TROUBLESHOOTING

To set up the system and make trouble shooting possible, it is required to connect the remote controller to the option kit.

### Not a malfunction of the air conditioner

#### *The system does not operate*

- The system does not restart immediately after the cooling/heating is requested.  
If the operation lamp lights, the system is in normal operating condition.  
It does not restart immediately because one of its safety devices actuates to prevent the system from being overloaded. The system will turn on again automatically after 3 minutes.
- The system does not restart immediately after the power supply is turned on.  
Wait 1 minute until the micro computer is prepared for operation.

### Trouble shooting

If one of the following malfunctions occurs, take the measures shown below and contact your dealer.

The system must be repaired by a qualified service person.

- If a safety device such as a fuse, a breaker, or an earth leakage breaker frequently actuates, or ON/OFF switch does not properly work.  
Turn off the main power switch.
- If the display  TEST, the unit number and the operation lamp flash and the malfunction code appears;  
Notify your dealer and report the malfunction code.

If the system does not operate properly, and none of the above mentioned malfunctions is evident, investigate the system according to the following procedures.

#### *If the system does not operate at all*

- Check if there is a power failure.  
Wait until power is restored. If power failure occurs during operation, the system automatically restarts immediately after the power supply recovers.
- Check if the fuse has blown or breaker has been tripped.  
Change the fuse or set the breaker.

#### *If the system stops operating after operation is complete*

- Check if the air inlet or outlet of outdoor or air handling unit is blocked by obstacles.  
Remove the obstacle and make it well-ventilated.
- Check if the air filter is clogged.  
Ask a qualified service person to clean the air filter.
- The error signal is given and the system stops.  
If the error resets after 5-10 minutes, the unit safety device was activated but the unit restarted after evaluation time.  
If the error persists, contact your dealer.

#### *If the system operates but it does not sufficiently cool/heat*

- Check if the air inlet or outlet of the air handling unit or the outdoor unit is blocked with obstacles.  
Remove the obstacle and make it well-ventilated.
- Check if the air filter is clogged.  
Ask a qualified service person to clean the air filter.
- Check if the doors or the windows are open.  
Shut doors or windows to prevent wind from coming in.
- Check if direct sunlight enters the room.  
Use curtains or blinds.
- Check if there are too many inhabitants in the room.  
Cooling effect decreases if heat gain of the room is too large.
- Check if the heat source of the room is excessive.  
Cooling effect decreases if heat gain of the room is too large.

#### *The air handling unit is freezing up*

- The liquid thermistor (R2T) is not put on the coldest position and part of the air handling unit is freezing up.  
Thermistor must be put on the coldest position.
- The thermistor has come loose.  
The thermistor must be fixed.
- The air handling unit fan is not operating continuously.  
When the outdoor unit stops operating, the air handling unit fan must continue operation to melt the ice that was accumulated during outdoor unit operation.  
Ensure that the air handling unit fan keeps operating.

In these cases, contact your dealer.

## MAINTENANCE



- Only a qualified service person is allowed to perform maintenance.
- Before obtaining access to terminal devices, all power supply circuits must be interrupted.
- Water or detergent may deteriorate the insulation of electronic components and result in burn-out of these components.

## DISPOSAL REQUIREMENTS

Dismantling of the unit, treatment of the refrigerant, of oil and of other parts must be done in accordance with relevant local and national legislation.



\*4PW52447-1 00000009\*

Copyright © Daikin

**DAIKIN EUROPE N.V.**

Zandvoordestraat 300, B-8400 Oostende, Belgium

4PW52447-1